

EN/CN-A01

Adventurer 4 / 冒险家4

# User Guide

# ≡ 用户使用手册 ≡

中文P28

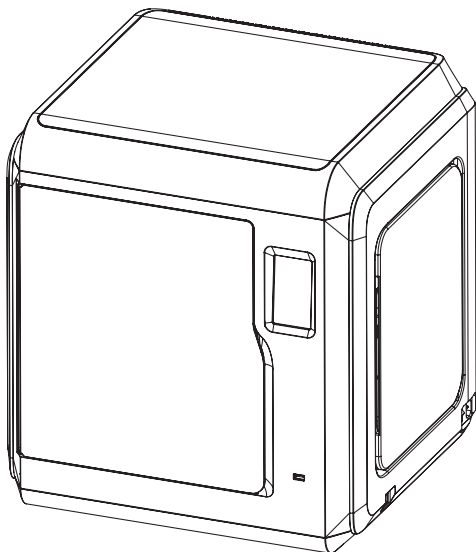

This guide is only applicable to FLASHFORGE Adventurer 4 3D printer

本手册仅适用于闪铸科技 冒险家4 3D打印机



# Content

<b>Notice</b>	<b>02</b>
<b>Reference</b>	<b>05</b>
<b>Chapter 1 Adventurer 4</b>	<b>06</b>
1.1 - Component Introduction	06
1.2 - Packing Specification	07
<b>Chapter 2 Introduction of User Interface</b>	<b>08</b>
2.1 - Build	08
2.2 - Prepare	10
2.2.1 - Preheat	10
2.2.2 - Filament	11
2.3 - Settings	12
2.4 - Maintain	13
2.4.1 - Upgrade	13
2.4.2 - Log	13
2.4.3 - Calibration	14
2.4.4 - ChangeExtruder	15
2.4.5 - Maintain	15
<b>Chapter 3 Software Installation</b>	<b>16</b>
<b>Chapter 4 Preparation of Device</b>	<b>16</b>
<b>Chapter 5 Print</b>	<b>17</b>
<b>Chapter 6 Q&amp;A</b>	<b>21</b>
<b>Chapter 7 Support and Service</b>	<b>27</b>

# Notice

## Safety Notice: please read and strictly follow all the safety warnings and notice below.

**Note:** Every printer has been tested before leaving factory. It is normal and will not be of trouble if there are filament residue remaining in the extruder or slight scratches on the plate.

### Work Environment Safety

- ◆ Keep your work place tidy.
- ◆ Do not operate Adventurer 4 in the presence of flammable liquids, gases or dust, which will cause fire in the high temperature generated by the equipment.
- ◆ Keep Adventurer 4 out of children and untrained people's reach.

### Electrical Safety

- ◆ Always use the Adventurer 4 with a properly grounded outlet. Do not refit Adventurer 4 plug. Ungrounded / improperly grounded / refitted plugs will increase the risk of leakage of electricity.
- ◆ Do not use Adventurer 4 in damp environment or under the burning sun. Damp environment will increase the risk of leakage / exposure to the sun will accelerate the aging of plastic parts.
- ◆ To avoid device damage, please use the power supply provided by Flashforge.
- ◆ Avoid using the device during a thunderstorm.
- ◆ In case of uncertain accident, please unplug the device if you do not use it for long.

### Personal Safety

- ◆ Do not touch the nozzle and build plate during printing.
- ◆ Do not touch the nozzle and plate after printing to avoid high temperature scald or mechanical damage!
- ◆ Dress properly. Do not wear loose clothing or jewelry. Keep your hair, clothing and gloves away from moving parts.
- ◆ Do not operate the device while you are tired or under the influence of drugs, alcohol or meditation.



## Cautions

- ◆ Keep the inside of the device clean and tidy. Do not place metal objects into the chute at the bottom of the platform.
- ◆ Please clean up the remaining in time. It is recommended to operate outside the equipment.
- ◆ Any modifications to the device will invalidate the guarantee.
- ◆ Lower the build plate before loading/unloading filament. The distance between the nozzle and build plate should be kept for at least 50mm.
- ◆ Operate the device in well-ventilated environment.
- ◆ Never use the device for illegal activities.
- ◆ Never use the device to make any food storage vessels.
- ◆ Never put the prints into your mouth.

## Environment Requirements

- ◆ Temperature: RT 15-30°C; moisture: 20%-70%.

## Place Requirements

- ◆ The device must be placed in a dry and ventilated environment. The distance of the left, right and back side space should be at least 20cm, and the distance of the front side space should be at least 35cm. Device storage temperature: RT 0-40°C.

## Filament Requirements

- ◆ It's recommended to use the filaments offered by Flashforge, or from the brands accepted by Flashforge. Due to the different properties of filaments, you need to modify printing parameters when using those which are not offered by Flashforge.

## Filament Storage

- ◆ All polymers degrade with time. Do not unpack filament until necessary. Filament should be stored in clean and dry conditions.

## Legal Notice

- ◆ All the information in this document is subject to any amendment or change without the official authorization from Flashforge.
- ◆ FLASHFORGE CORPORATION MAKES NO WARRANTY OF ANY KIND WITH REGARD TO THIS DOCUMENT, INCLUDING, BUT NOT LIMITED TO, THE IMPLIED WARRANTIES OF MERCHANTABILITY AND FITNESS FOR A PARTICULAR PURPOSE.
- ◆ FCC Notice  
This device complies with part 15 of the FCC rules. Operation is subject to the following two conditions: [1] This device may not cause harmful interference, and [2] this device must accept any interference received, including interference that may cause undesired operation.
- ◆ Flashforge shall not be liable for errors contained herein for incidental consequential damages in connection with furnishing, performance or use of this material.
- ◆ This document contains proprietary information protected by copyright. Copyright © 2021 Flashforge Corp. All Rights Reserved.

# Reference

<b>Name</b>	Adventurer 4
<b>Number of Extruder</b>	1
<b>Positioning Accuracy</b>	X/Y axis: 0.011 mm; Z axis: 0.0025 mm
<b>Layer Resolution</b>	0.1~0.4 mm
<b>Build Volume</b>	220 x 200 x 250 mm
<b>Nozzle Diameter</b>	0.4mm (default) 0.6/0.3 mm(optional)
<b>Build Speed</b>	10~150mm/s
<b>Highest extruder Temperature</b>	265°C/240°C
<b>Filament Support</b>	ABS/PLA/PC/PETG/PLA-CF/ASA/PETG-CF
<b>Power Supply</b>	AC100-240V/DC 24V/13.3A,320W
<b>Device Size</b>	500(L)*470(W)*540(H) mm
<b>Package Size</b>	585(L)*570(W)*680(H) mm
<b>Software</b>	FlashPrint
<b>Input/Output File</b>	Input: 3MF/STL/OBJ/FPP/BMP/PNG/JPG/JPEG File; Output: GX/G File
<b>Connectivity</b>	USB Disk/ WIFI/ Ethernet
<b>Printing Environment</b>	15-30°C

# Chapter 1 Adventurer 4

## 1.1 Component Introduction

1. Power switch
2. Power socket
3. Filament cover
4. Spool holder
5. Filament intake cover
6. Front cover
7. Platform base
8. Build plate
9. Touch screen
10. USB
11. Ethernet input

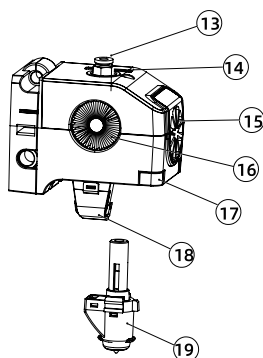
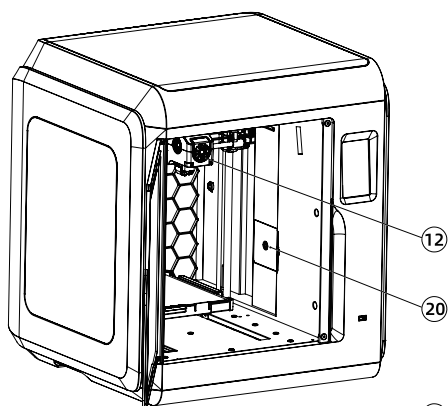
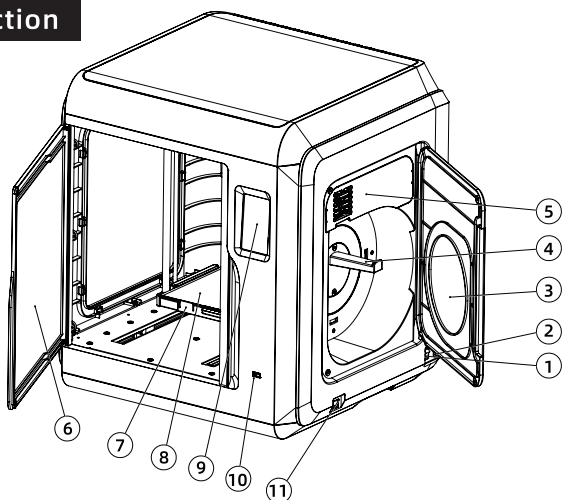

12. Extruder
13. Filament guide tube joint
14. Cable slot
15. Fan for cooling model
16. Fan for cooling extruder
17. Buckle
18. Air duct
19. Nozzle
20. Camera
21. Air filter

## 1.2 Packing Specification

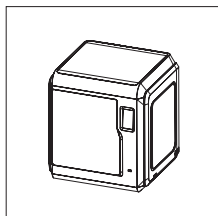

3D Printer

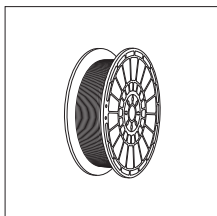

Filament

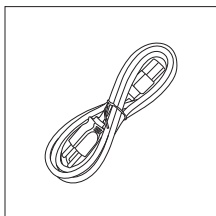

Power Cable

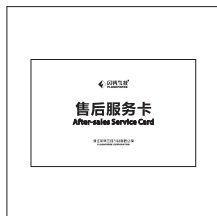

After-Sales  
Service Card

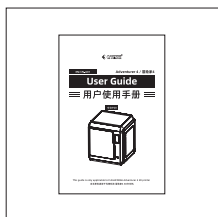

User Guide

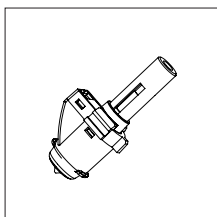

0.4-265 Nozzle  
(Adventurer 4 Equipped)

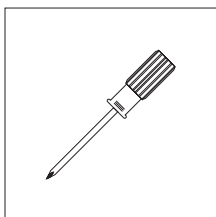

Screwdriver

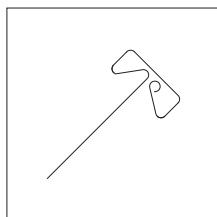

Unclogging  
Pin Tool

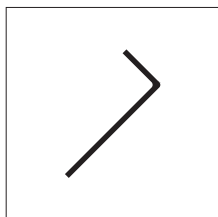

Allen Wrench

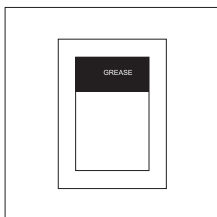

Grease

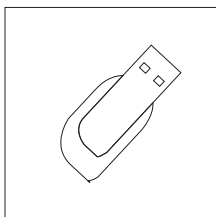

USB Disk

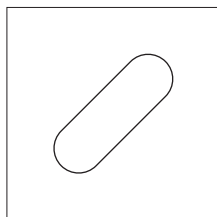

Leveling Card

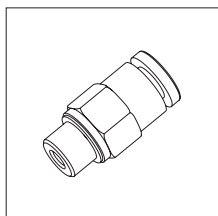



Filament Guide  
Tube Joint

# Chapter 2 Introduction of User Interface

**Note** The interface layout may change whenever there is an upgrade of firmware. The functions below are only for demonstration purposes.

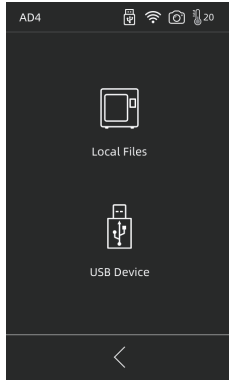
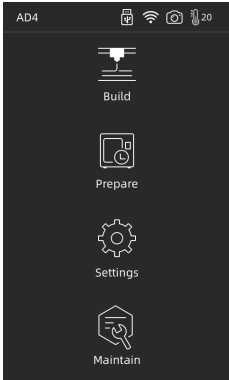
## 2.1 Build



-  Read print file from local memory card
-  Read print file from the USB stick

1. Click [Build], and then choose the path to read the print file.



2. File list

**Tap model file:** for file details.

**Long press model file:** multi-selecting mode on.

The finished prints will be marked.

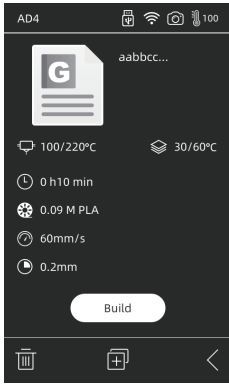

### Details

- Extruder temperature
- Build plate temperature
- Time used
- Amount and type of filaments required
- Speed
- Layer thickness
- Copy the file to the local memory card

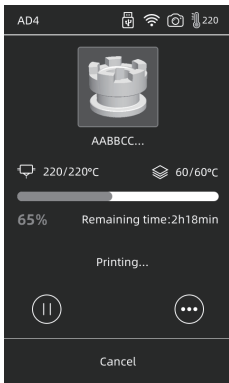

### Interface

- Pause/Resume printing
- Check more parameter settings and details

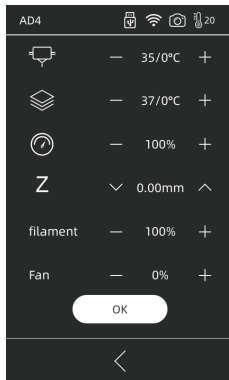
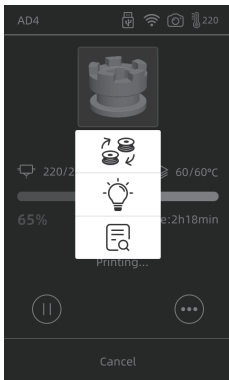

### More Settings

- You can change filaments
- The switch of LED light
- Adjust printing parameters: extruder temperature/ platform temperature/ printing speed

**Z:** Used when the distance needs to be adjusted between the first printed layer and the extruder. The up and down arrows indicate that the extruder moves upward or downward.

**Fan:** The fan for cooling the model. Wind speed can be adjusted for printing different filaments.

Click OK to save and apply the changed parameters.

## 2.2 Prepare

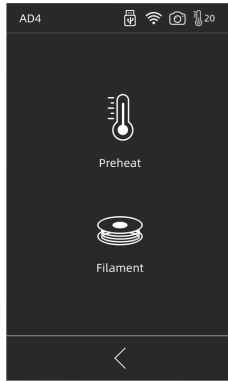
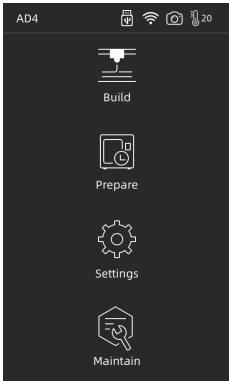



### Prepare

-  Preheat
-  Filament

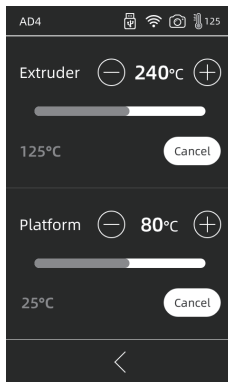
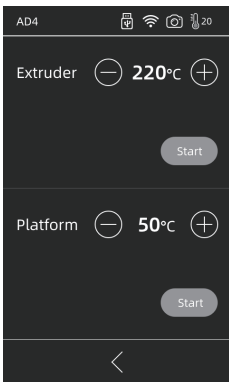
### 2.2.1 Preheat



Tap   to set preheat temperature.

Long press   to set preheat temperature speedily.

Turn ON/OFF the extruder or platform preheat

**Extruder highest preheat temperature: 265°C** (It's up to the chosen extruder)

**Platform highest preheat temperature: 110°C**

Temperature can be adjusted anytime during heating.



## 2.2.2 Filament

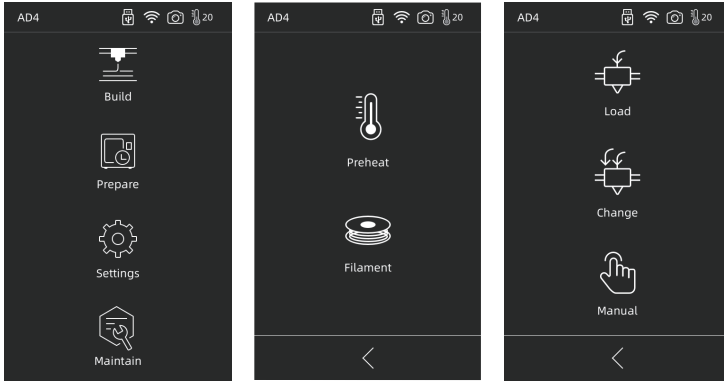

### Load/Change/Manual

#### Load

Choose [Load], extruder will be heated to set temperature, then follow the instruction to finish loading. Note that fast+slow loading is automatically applied, just place the filament in the extruder gear. Do not push the filament into the tube. You may hear noise when the loading is fast.

#### Change

Click on [Change], the extruder will be heated up to the preset temperature. Pull out the filament according to the instruction. Insert new filament in the filament intake until some resistance is felt. New filament coming out of extruder indicates a successful replacement.

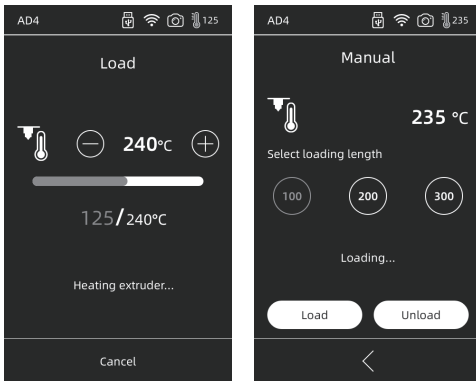

#### Manual

Click on [Manual], extruder will be heated up to preset temperature. Choose filament length, and choose [Load/Unload].

**Note** Note that manual mode should be preferred when there is remaining filament in the tube.

## 2.3 Settings

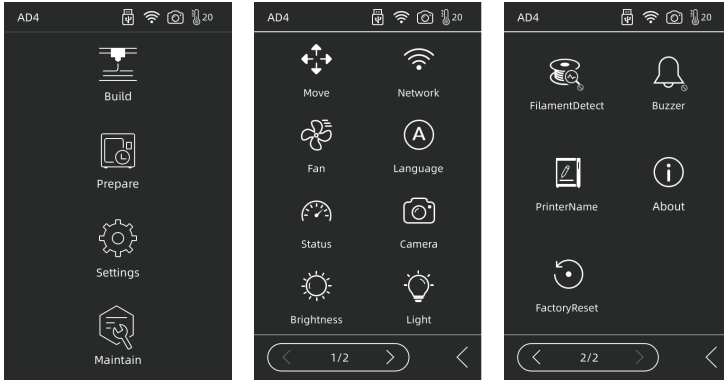





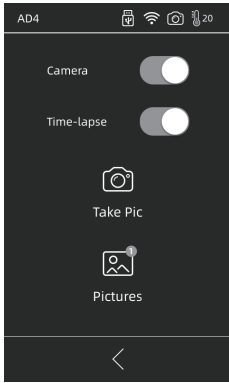

The following functions are included in [Settings]: **Move**, **Network**, **Fan**, **Language**, **Status**, **Camera**, **Brightness**, **Light**, **FilamentDetect**, **Buzzer**, **PrinterName**, **About**, **FactoryReset**.

- ❖ **Move**: to move the extruder left or right, (note that the noise is normal if it moves past the farthest point of the left side), and to move the build plate back and forth, (note that the noise is normal if it moves past the farthest point of the front side);
- 📶 **Network**: connect device to hot spot/WLAN/Flash Cloud/Polar Cloud;
- 🌀 **Fan**: to turn on/off the fan;
- Ⓐ **Language**: select language;
- 🌡️ **Status**: including device temperature, X/Y/Z position, etc.





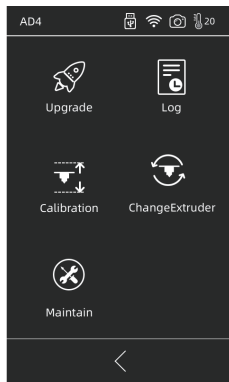
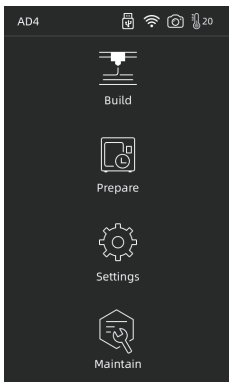

 **Camera:** Remote monitoring. Turn on the camera during printing, and turn on time-lapse, and time-lapse video can be recorded in the memory disk; it can be found in [Pictures]; choose [Take Pic], the live scene is saved as images;

-  **Brightness:** Adjust the screen brightness;
-  **Light:** turn on/off the light on the extruder;
-  **FilamentDetect:** filament check sensor is on/off;
-  **Buzzer:** Turn on/off the sounds of device startup and screen click;
-  **PrinterName:** User can name the device;
-  **About:** information of this device;
-  **FactoryReset:** this device is restored to factory setting.

## 2.4 Maintain



### Maintain

-  Upgrade
-  Log
-  Calibration
-  ChangeExtruder
-  Maintain

### 2.4.1 Upgrade

When the device is connected to the network, it will be prompted to upgrade when the new firmware is released;

### 2.4.2 Log

When the equipment has abnormal movements, the problem can be fed back to the official after-sales team of Flashforge by copying the log.

### 2.4.3 Calibration

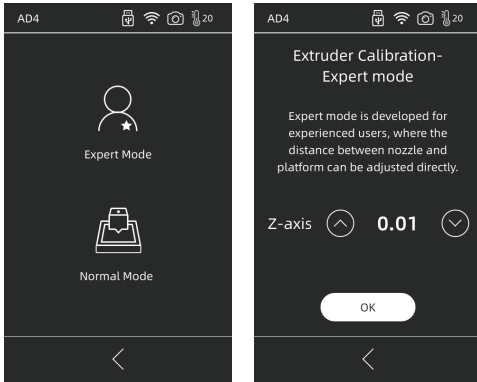

It is necessary to calibrate the distance between the nozzle and the platform after the first use or replacement of the nozzle;

Expert mode: Expert mode is for experienced users to directly calibrate the distance.

Click (⬆️) to make extruder move upwards, Click (⬇️) to make extruder move downwards.

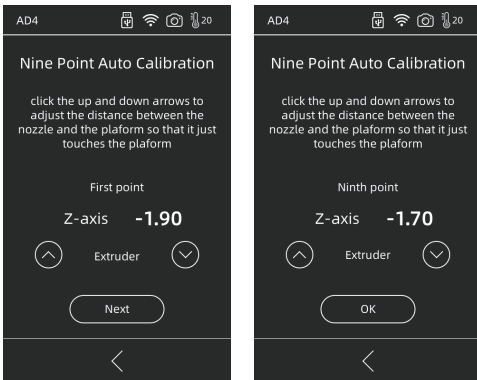

**Normal Mode** : extruder calibration and 9-point leveling offset are included.

Click on [Normal Mode] to start pre-calibration. The first point is to calibrate the initial distance between the extruder and the platform. Click on the up and down arrows to adjust the Z-axis deviation value. You can also sense if there is slight resistance by pulling A4 paper between them to decide the appropriate distance. In general, no further adjustment is needed. If large size model still cannot be printed after extruder calibration, or failure occurs due to uneven platform, please finish 9-point leveling by calibrating all 9 points. After calibration, the software will automatically calculate a mean value for compensation; when calibrating each point, the user can also adjust the z-axis deviation by clicking the up and down arrows; after compensation, the value can be calculated and applied.

## 2.4.4 ChangeExtruder

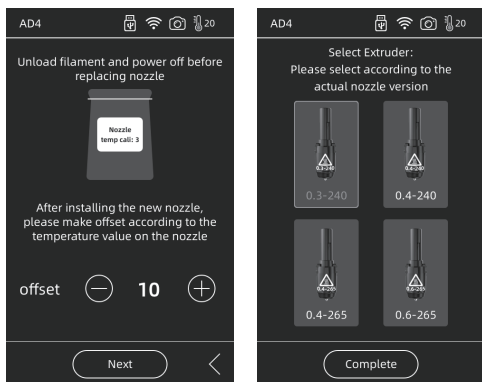

After installing a new nozzle, please set the compensation value according to the temperature the replaced nozzle adopts to; the actual deviation range of the extruder:  $-10 \sim 30$ . Click [next] to enter the extruder selection interface. Select the new nozzle to be installed and the maximum temperature during preheating will be set according to the selected nozzle. Please ensure that the installed nozzle is the same as the selected nozzle type, and click [Complete] to return to the maintenance interface.

**Note** if a different nozzle is replaced, the default maximum temperature of preheating will change to the temperature of the replaced nozzle.

## 2.4.5 Maintain

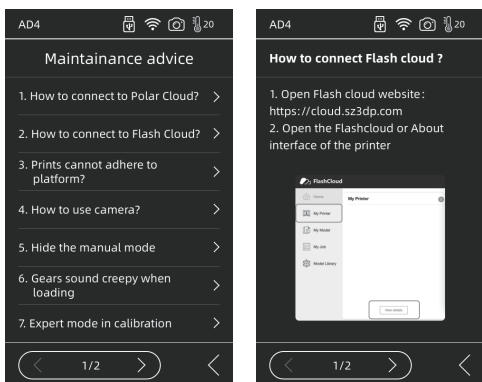

In case of errors or unclear operation, please check and operate according to the maintenance suggestions first.

# Chapter 3 Software Installation

---

Find the FlashPrint installation package in the USB disk and select the version corresponding to your system to install.

Or you can download it from <https://www.flashforge.com/download-center>.

# Chapter 4 Preparation of Device

---

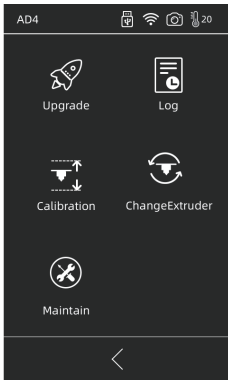

The equipment has been leveled and calibrated before delivery, but due to transportation or other influences, the distance between nozzle and platform may change. It is recommended to conduct [Calibration] after unpacking.

**This step is optional, please refer to the interface function introduction before operation.**

# Chapter 5 Print

---

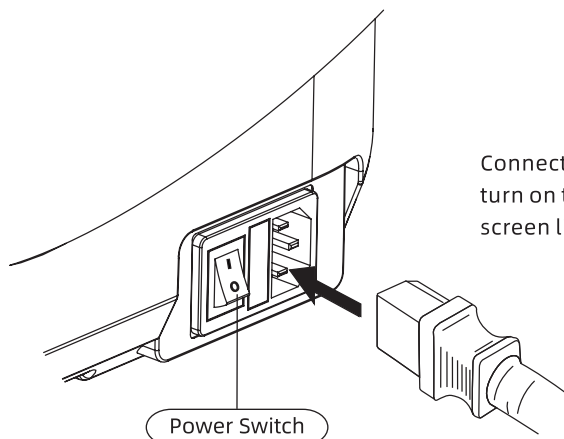

Connect cable to printer;  
turn on the switch, the  
screen lights up.

1. Connect to power.

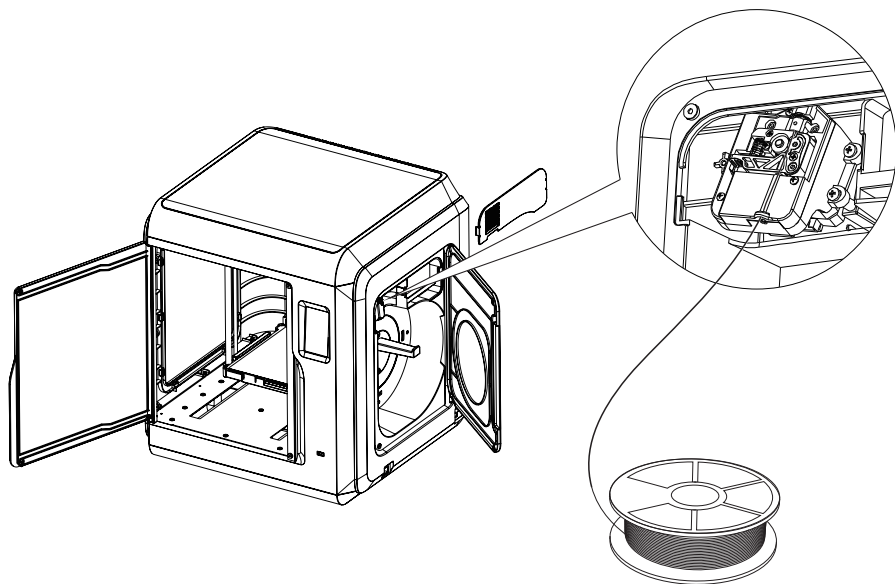

2. Load Filament: open the filament cover on the right side, insert the filament into the filament intake, push filament into the feeding wheel until some resistance is felt. Please make sure filaments are in the feeding wheel. Tap [Prepare]-[Filament]-[Load]. Follow the instruction, filament coming out of the nozzle indicates a success.

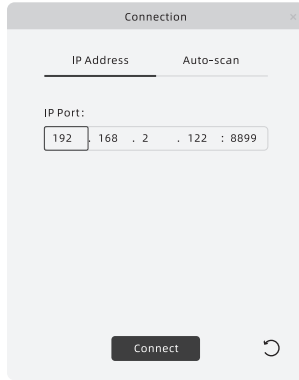
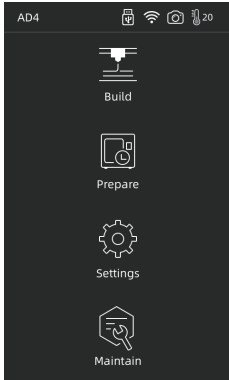

**Note**

When the user wants to use the browser to view images, the printer and PC must be in an intranet (that is, the printer and PC connect to the same router).

### 3. Model File Transfer

#### Method 1: Wi-Fi Connection

Tap [Settings]-[Network]-[WIFI], operate according to the instruction. Open FlashPrint, click [Print], then click [Machine Type], select [FlashForge Adventurer 4]. You can try to enter the IP address or scan it automatically. The IP address can be viewed in [settings] - [about].

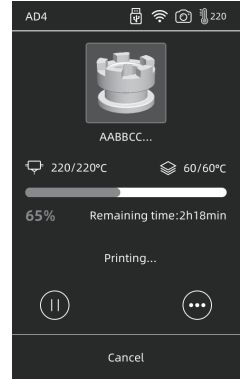
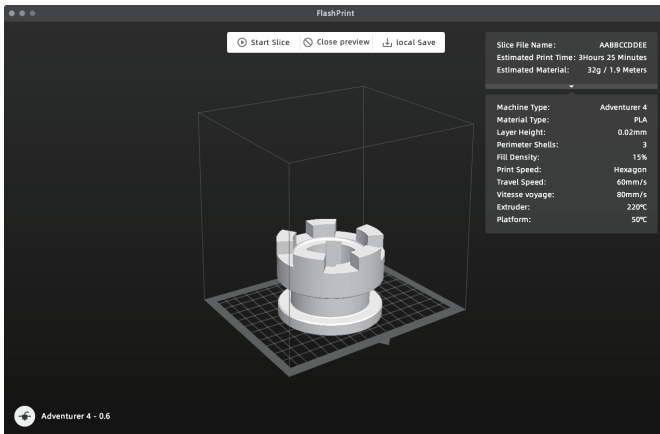

Import stl or obj file into the slicer; after slicing, the printer will heat up and start printing automatically.

#### Method 2: USB Device

Files can be read in USB disk. Insert USB disk and select the files to print.



### Method 3: Cloud

#### FlashCloud

(1) Open FlashCloud website (<https://cloud.sz3dp.com>) to register an account. After the mailbox is activated, you can log in and use it; after logging in.

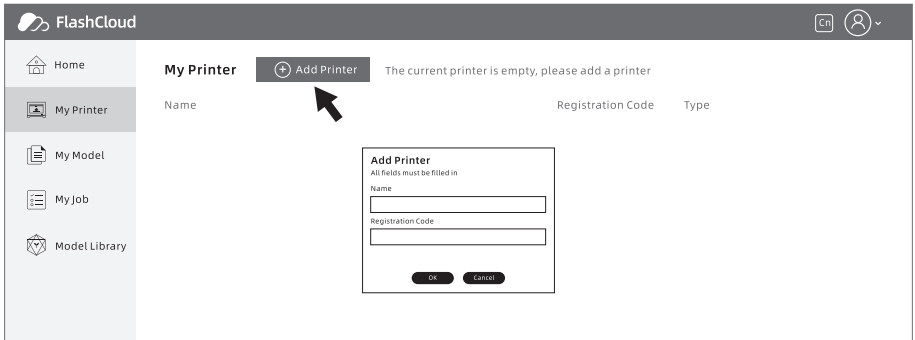

(2) Click [My Printer] - [Add Printer]. Fill in the registration number (Registration Code) on page and name the printer. After clicking OK, the information will appear in the FlashCloud interface of the printer.

#### Polar Cloud

Register the Polar Cloud account in <https://Polar3d.com>.

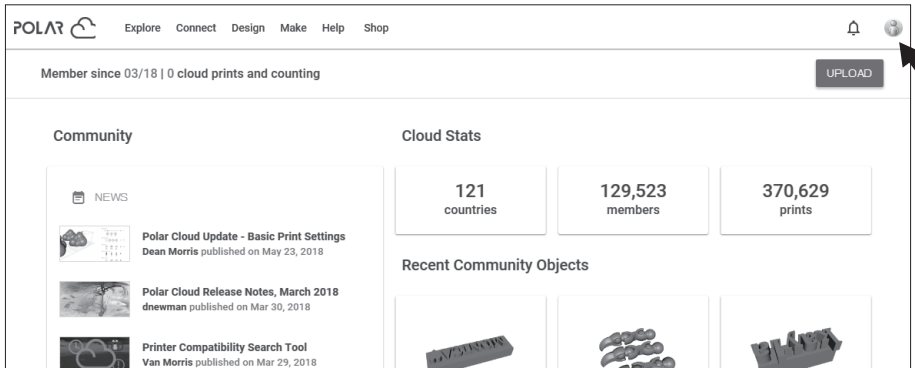

Inquire Polar Cloud PIN code. Turn on the Polar Cloud switch and enter account number and PIN after connecting Adventure 4 to network.

#### 4. Model Removal

Take out the removable build plate, and bend the plate to get the model.

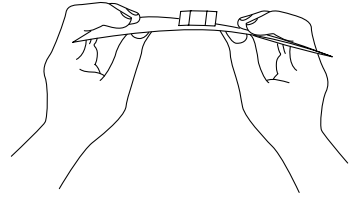
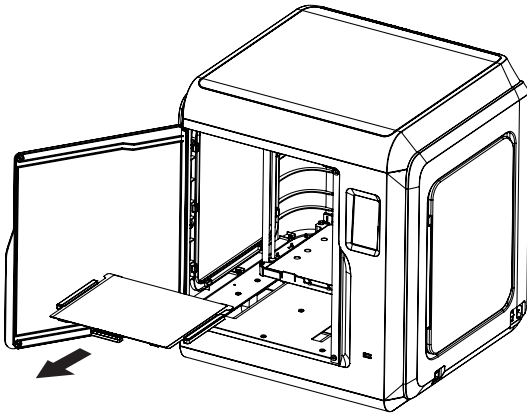

**⚠ Note**

Nozzle and build plate are still hot after finishing printing, please wait for them to cool down before you operate.

It is recommended to take the plate to the outside of the equipment for model removal, otherwise the model debris will remain in the equipment. Please keep the inside of the printer clean.

# Chapter 6 Q&A

---

## Q1. How to unlog the nozzle?

Method1: Tap [Preheat], heat up the nozzle to the set temperature. Once completing heating, press the filament guide tube joint and pull out the filament guide tube. Check to see whether the filament is bent or filament's cross-section is smooth. If not, cut it smooth, install the guide tube and filament back. Tap [Load].

Method2: If method 1 does not work out, use an unlogging pin tool to unlog filament.

Method3: If method 1&2 do not work out, please replace the nozzle.

## Q2. How to replace the nozzle?

**⚠ Note** Power off before replacing nozzle! No power on operation!

1. Press the left and right clips and pull out the nozzle.
2. Push in the filament through the filament intake manually, making it long enough to be cut off;
3. Rotate the filament spool anti-clockwise manually, making filament retreat a little;
4. Press the left and right clips, install the new nozzle. Make sure nozzle slot and bottom of extruder are on the same level.
5. Tap [Prepare] -- [Load], filament coming out of the new nozzle indicates successful replacement.

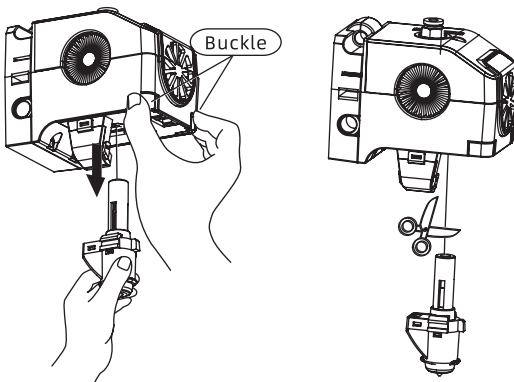

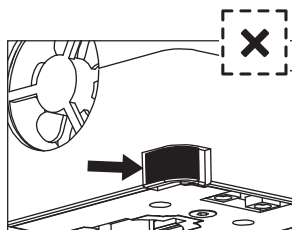
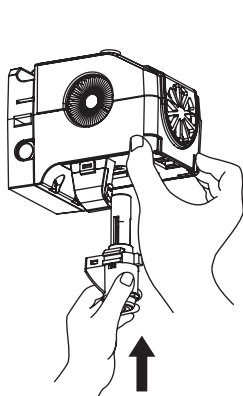

Improperly installed  
with seam

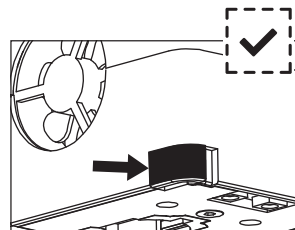

Properly installed with  
no seam

Whether the extruder assembly is in place is judged as follows:

1. When installed, the extruder must be pushed to the end;
2. Check whether the installation is in place:
  - ① Touch the black buckle and the lower shell of the white extruder, make sure no hollows are felt;
  - ② Observe to make sure there is no large gap in the joint of the black buckle and the lower shell of the white extruder.

### Q3. Do we need to calibrate the extruder after replacing nozzle?

Yes, small errors may occur because of the calibration. To keep best printing quality, you need to calibrate it again.

### Q4. What can I do if no filament comes out of the extruder after I choose the file and the extruder moves normally?

1. Check the filament guide tube, make sure the filament has been pushed into the extruder; if not, please tap [Load] till filament comes out;
2. check whether the extruder is clogged, if so, please refer to Q1.

### Q5. How to solve if the distance between nozzle and platform is too large(far away) or too small(that they collide)?

1. Tap[Maintain]--[Calibration];
2. The printer starts pre-calibrating. The first point is to calibrate the initial distance between the extruder and the platform (see Z-axis deviation value). Click the up and down arrows to adjust the Z-axis deviation value. With the help of the leveling card, you can feel if there is any slight resistance to decide the appropriate distance.
3. When the extruder is still unable to properly print a large size model after calibration, or when the model fails to be printed due to uneven platforms, please continue using this function. The machine will calibrate the remaining 8 points. After calibration is completed, the software will automatically calculate a compensation mean to compensate. When each point is being calibrated, the user can also adjust the Z-axis deviation by clicking the up and down arrows. After compensation is completed, the value is memorized and the extruder goes back to zero.

**Q6. Can we use other brand filament which is not produced by Flashforge?**

Adventurer 4 supports ABS, PLA, PC, PETG, PLA-CF, PETG-CF, etc., which have different ingredients. Adventurer 4 tests out default settings like temperature and filament output to ensure the best printing quality. Other brands of filaments can be used with the parameters adjusted. Because the required temperature between different materials is slightly different, it is recommended to clean the previous filaments before using new filaments, otherwise it is easy to cause extruder blockage.

**Q7. Is Adventurer 4 compatible with all kinds of AC power input?**

Adventurer 4 is equipped with a built-in 24V/13.3A power supplier, suitable for 100V-240V input voltage.

**Q8. Is Adventurer 4 capable of turning itself off automatically after printing job is finished?**

No .

**Q9. What kinds of file formats does Adventurer 4 support?**

Input: 3MF/STL/OBJ/FPP/BMP/PNG/JPG/JPEG Files.  
Output: GX/G files.

**Q10. Does Adventurer 4 support other cloud platforms besides FlashCloud?**

Yes, Adventurer 4 interface is open up to all other cloud platforms.

**Q11. Is the ABS printing safe?**

ABS filament will give off certain poisonous gas when heated up, please put the printer in well-ventilated condition when printing ABS. We suggest using non-toxic PLA filament when printer is near children.

**Q12. How to solve edge warping and weak adhesion?**

- Method1: Heating up the platform can increase adhesion between platform and model.
- Method2: Adding raft to model when slicing in FlashPrint.
- Method3: Apply solid glue to platform before printing.
- Method4: Use extruder calibration in expert mode or leveling calibration to reduce the distance between the nozzle and the platform.
- Method5: Make sure the platform is flat. Complete 9-point leveling suggested.
- Method6: Apply extruder calibration to reduce the gap.

**Q13. Is it a must to add a raft before printing the model?**

Not necessarily. More filaments come out of the nozzle when printing the raft, higher success rate there will be. When the plate is heated, the adhesion between the model and the platform increases, which makes the model adhere to the platform well when printing, and also increases the success rate.

**Q14. After replacing the nozzle, printer status indicates that extruder temperature is 300°C, and the fan is also working. Why is this happening?**

**Note:**

Note that the temperature setting in the slicer file might not match the highest temperature of the replaced nozzle.

**Errors:**

Errors in temperature displaying indicate that the new nozzle is not properly installed, and the extruder temperature cannot be read by the sensor. Please plug out and install the extruder again, make sure that the extruder is pushed to the end, and the buckle and bottom of extruder are on the same level. Refer to Q2.

 **Note** Power off when replacing the nozzle.

**Q15. The extruder makes out chug noise and no filament comes out of the extruder, what is the problem and how to solve?**

Filament has not loaded into extruder, which is most likely because the extruder is clogged or filament guide tube is not properly installed. Check the guide tube joint first, if it's normal, refer to Q1 for resolution.

**Q16. What is the difference between filament loading, filament replacement and manual mode?**

Load: only load filament into the extruder;  
Change: first unloading and then loading filament, from fast to slow;  
Manual: slow loading.

 **Note** it is recommended to use manual mode during testing the nozzle unloading filaments. Not recommended for loading filaments. If it is used, please select the maximum length.

**Q17. Adventurer 4 starts printing when the distance between extruder and build plate is still large, causing filament unable to stick to plate.**

Calibrate the printer again or finish Homing again before giving it another go.

**Q18. Printing files cannot be found when using USB driver?**

USB driver file is not correct. Adventurer 4 only supports FAT32 file system, please format USB driver into FAT32 file system.

### Q19. How to connect to Polar Cloud?

1. Open Polar Cloud website, and log in account. <https://polar3d.com>;
2. Click in Cloud Account on the right top corner, roll down the page to find PIN code;
3. Open Polar Cloud on the printer, enter account number and PIN code;
4. Turn on the switch and connect to Polar Cloud.

### Q20. How to connect to FlashCloud?

1. Open FlashCloud website: <https://cloud.sz3dp.com/login.html>;
2. Open FlashCloud interface or about on the printer;
3. Add the printer on FlashCloud website, enter name and registration code of printer;
4. Turn on the FlashCloud switch to connect the printer.

### Q21. How to use camera?

1. Turn on camera to watch live video on the Cloud;
2. Time-lapse function will take 100 pictures during printing and makes a video.



**Note** Pictures can contain up to 10 models, while videos 20 models.

### Q22. Operation of movement

1. When the length is not selected, press the button to start the movement, and release the button to stop the movement;
2. When the length is selected, press to start the movement, release will not stop the movement until the corresponding length is reached.



**Note** Pay attention to the distance when it moves along the side to avoid hitting the border.

### Q23. Noise in the gear when loading filaments?

The printer adopts fast-slow loading, make sure there is no remaining filament in the guide tube.

### Q24. What is expert mode in calibration?

In expert mode, the distance can be adjusted directly for experienced users. Details can be found in the calibration instructions for expert mode.

### Q25. How to set printing parameters during printing?

Set printing parameters in the printer. Note that adjustments might be delayed to take effect, or improper adjustments will affect printing quality, please set it with caution.

## Q26. Wi-Fi connection failure?

1. Please check if there are any special characters in the Wi-Fi hotspot name, if there are any, please modify them and try again;
2. Check your password for special characters, and if so, try again after you have modified it.

**⚠ Note** Make sure the password is entered correctly.

## Q27. Firmware update

Please do not disconnect the network during download or update to prevent update failure.

## Q28. Turn on the printer with white screen and no firmware

1. If you hear the power-on sound, change the screen or the wiring;
2. If you cannot hear the power-on sound, please contact the supplier.

## Daily Maintenance Instructions:

When the printer is not used for a long time, apply grease on the guide rail, do it regularly every other month. Put filaments in the drying box to prevent moisture.

If it is used frequently, it is recommended to replace HEPA filter cotton once every 2 weeks.

Replace as follows:

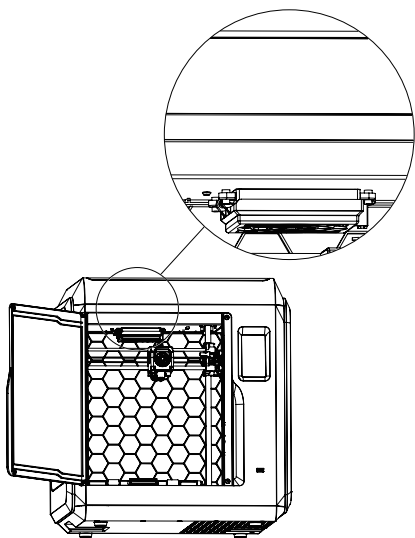

1. Open the front door of printer, and find the air filter device indicated in the picture.

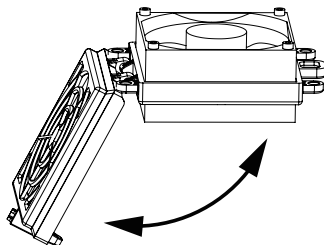

2. Open the air filter cover, put in a new cotton filter, and close the filter cover.



# Chapter 7 Support and Service

---

Flashforge team is on standby and ready to help you with any challenges you may have with your 3D printer. If the issues or questions are not covered in this User Guide, you can seek for solutions on our official website or contact us via telephone.

There are solutions and instructions to common issues that can be found in our knowledge base. Have a look first as most basic questions are answered there.  
<http://www.flashforge.com>

The Flashforge support team can be reached by e-mail or phone between the working hours of 8:00 a.m. to 5:00 p.m. PST Monday through Saturday. In case you contact us during off-duty time, your inquiry will be answered the following business day.

**Note:** Because of changing different filament the extruder maybe blockaded. It's not owing to quality issue, and outside the scope of 400 hours life. If users encounter this problem, please contact our after-sale department and finish clean work according to their instruction.

Facebook Official Group Address: Flashforge Official User Group

Email: [support@flashforge.com](mailto:support@flashforge.com)

Address: No.518 XianYuan Road, Jinhua City,Zhejiang Province, China



# 目录

注意事项	29
设备参数	31
第一章 设备简介	32
1.1 - 整机介绍	32
1.2 - 装箱清单	33
第二章 设备操控界面简介	34
2.1 - 打印	34
2.2 - 准备	36
2.2.1 - 预热	36
2.2.2 - 丝料	37
2.3 - 设置	38
2.4 - 维护	39
2.4.1 - 在线升级	39
2.4.2 - 日志	39
2.4.3 - 喷头校准	39
2.4.4 - 喷头更换	40
2.4.5 - 维护建议	41
第三章 软件安装	41
第四章 设备预准备	41
第五章 首次打印	42
第六章 Q&A	46
第七章 帮助与支持	51

# 注意事项

## 安全提示：请确保认真阅读以下安全提示

注意：每台3D打印机在出厂前都经过打印测试，若设备喷头存在耗材残留或打印平台有轻微划痕，均属正常现象，不影响使用。

### 工作环境安全

- ◆ 请保证打印机的工作台面干净整洁。
- ◆ 请保证打印机工作时远离可燃性气体、液体及灰尘。设备运行产生的高温有可能会与空气中的粉尘、液体、可燃性气体反应引发火灾。
- ◆ 儿童及未经培训的人员请勿单独操作设备。

### 用电操作安全

- ◆ 请务必将设备接地；切勿改装设备的插头。未接地 / 未正确接地 / 改装插头必然会增加漏电风险。
- ◆ 请勿将设备暴露在潮湿或烈日的环境中。潮湿的环境会增加漏电的风险 / 暴晒会加速塑件老化。
- ◆ 请勿滥用电源线，务必使用闪铸科技提供的电源线。
- ◆ 切勿在雷雨天气使用设备。
- ◆ 如长时间不使用设备，请关闭设备并拔下电源线插头。

### 个人操作安全

- ◆ 在设备运行时，请勿触碰喷头、平台等位置！
- ◆ 在打印完成时，请勿触碰喷头、平台，以免高温烫伤或机械损伤！
- ◆ 在操作设备时，请勿穿戴围巾、口罩、手套、珠宝装饰等容易卷入设备的物件！
- ◆ 请勿在饮酒、服药之后操作设备！

### 设备使用提示

- ◆ 保持设备内部整洁，切勿将金属物体掉入打印平台底部的滑槽内。
- ◆ 请及时清理丝料碎屑，建议在设备外进行操作。
- ◆ 自行对该设备进行任何改装将自动失去保修保障。
- ◆ 请在设备进丝操作时，喷头和平台的距离至少保持50mm的距离。距离过近可能会造成喷头堵塞。
- ◆ 请在通风的环境下操作设备。
- ◆ 请勿利用该设备进行违法犯罪的活动。
- ◆ 请勿利用该设备制作食物储存类产品。
- ◆ 请勿将打印模型放入口腔。

### 设备运行环境要求

- ◆ 室内温度在15-30℃为宜；湿度在20%-70%为宜。

### 设备放置要求

- ◆ 设备需要放置于干燥通风的环境中。设备左侧、右侧以及后侧必须要留至少20cm的距离，前侧必需要留至少35cm的空间距离。存储温度0-40℃为宜。

### 设备兼容耗材要求

- ◆ 在使用该设备时，建议使用闪铸提供或指定的耗材。如使用非闪铸提供耗材，材料特性有所差异，打印参数可能需要调整。

### 耗材存储要求

- ◆ 耗材拆封后请保持储存环境干燥，无尘，建议配套干燥盒存储。

### 法律申明

- ◆ 用户无权对此使用手册进行任何修改。
- ◆ 客户若自行拆装或改造设备造成任何安全事故，闪铸科技概不负责。未经闪铸科技允许，任何人不得对该手册进行修改或翻译。本手册受版权保护，闪铸科技对本手册保留最终解释权。
- ◆ 第一版（2021年4月）  
@Copyright 2021浙江闪铸三维科技有限公司 版权所有

# 设备参数

设备名称	冒险家4
喷头数量	1
定位精度	X/Y 轴: 0.011 mm; Z 轴: 0.0025 mm
打印层厚	0.1~0.4 mm
成型尺寸	220 x 200 x 250 mm
喷嘴口径	0.4mm (默认) 0.6/0.3 mm (可选)
打印速度	10~150mm/s
最高喷头温度	265°C/240°C
支持耗材类型	ABS/ PLA/ PC/ PETG/ PLA-CF/ ASA/ PETG-CF
电源	AC100-240V/DC 24V/13.3A, 320W
设备尺寸	500 (L) *470 (W) *540 (H) mm
包装尺寸	585 (L) *570 (W) *680 (H) mm
匹配软件	FlashPrint
输入/输出文件	输入: 3MF/STL/OBJ/FPP/BMP/PNG/JPG/JPEG文件; 输出: GX/G文件
通讯	U盘/ 无线网/ 以太网
打印环境	15-30°C

# 第一章 设备简介

## 1.1 整机介绍

1. 电源开关
2. 电源插座
3. 丝盘门
4. 料盘架
5. 送丝盖板
6. 前门
7. 平台底座
8. 平台板
9. 触控屏
10. USB
11. 网口

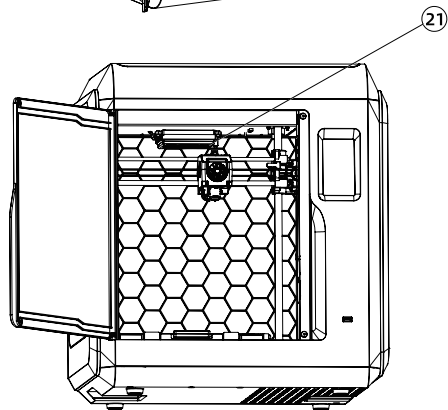
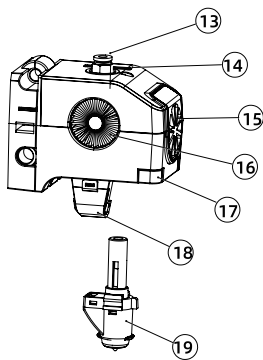
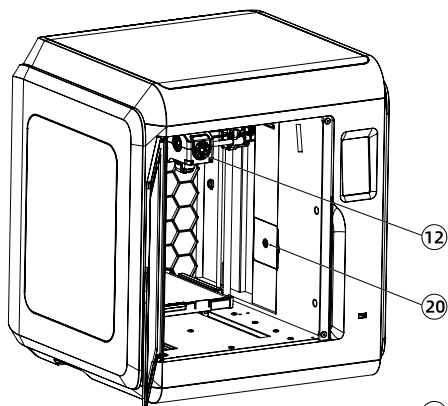
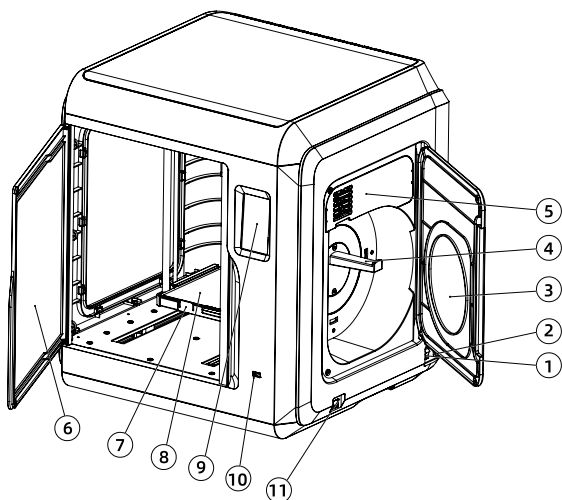

- |            |            |
|------------|------------|
| 12. 喷头     | 13. 气管接头   |
| 14. 排线槽    | 15. 模型冷却风扇 |
| 16. 喷头冷却风扇 | 17. 卡扣     |
| 18. 导风嘴    | 19. 喷嘴     |
| 20. 摄像头    | 21. 空气过滤   |

## 1.2 装箱清单

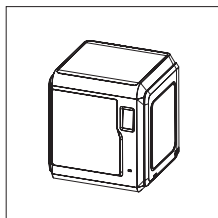

3D打印机

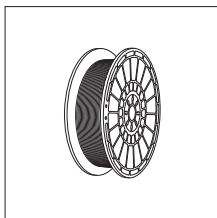

3D打印耗材

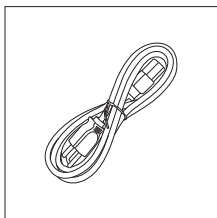

电源线



售后服务卡

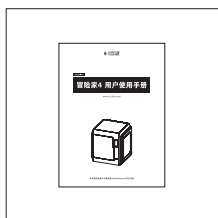

说明书

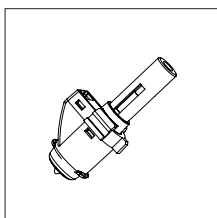

0.4-265喷嘴  
(冒险家4 配置)

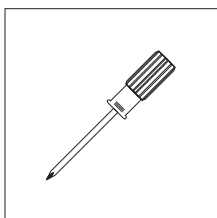

十字螺丝刀

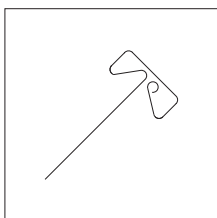

通针

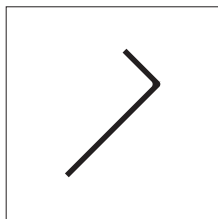

内六角扳手

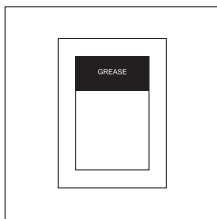

润滑脂

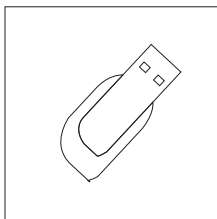

U盘

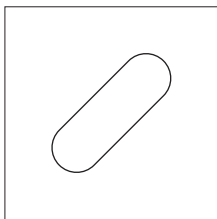

调平卡

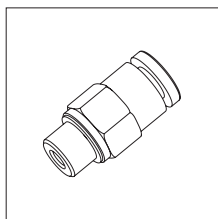

气管接头



# 第二章 设备操控界面简介

## ⚠ 注意事项

固件不定期升级，界面请以实际显示页面为准。以下仅为功能简介。

## 2.1 打印



-  从打印机本地存储卡中读取
-  从外接U盘中读取打印文件

1. 在首页点击打印图标，选择读取打印文件的路径。

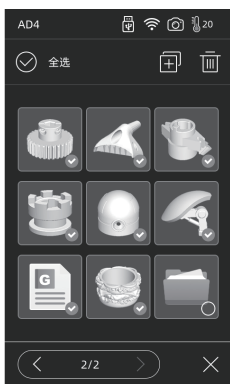
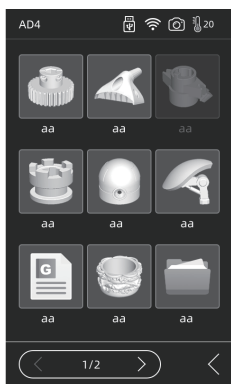

2. 文件列表

点击任一模型文件：进入文件详情页面；

长按任一模型文件：开启多选模式。

打印完成的模型会进行标记



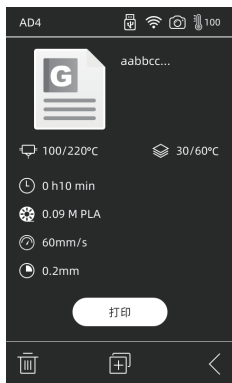



## 文件详情

-  喷头温度
-  加热平台温度
-  打印时长
-  耗材所需总量及名称
-  打印速度
-  层厚度
-  将文件复制到本地存储卡中



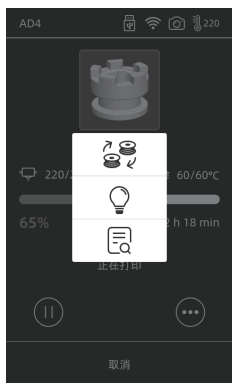

## 打印界面

-  暂停打印/恢复打印
-  弹出更多弹窗，可进行参数调节



## 更多设置

-  可进行换丝
-  照明灯的开/关
-  调整打印参数：可修改喷头温度/平台温度/打印速度

**Z**: Z轴补偿，若打印第一层平台与喷头间距不适合，可点击进行调整。向上箭头表示喷头向上移动，向下箭头表示喷头向下。

**风扇**: 可调节喷头的模型冷却风扇，可调节风速以适应不同材料打印。

点击确定按钮，所改动的参数被保存并应用。

## 2.2 准备



### 准备界面

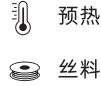

### 2.2.1 预热



点击 **(+)** **(-)** 可设定预热温度值；

长按 **(+)** **(-)** 温度值快速调整。

点击开始，启动预热；点击取消，预热结束。

喷头最高温度：265°C（可设置最高温度实际依据喷头选择而定）

加热平台最高可设置温度：110°C

加热过程中可随时调节温度。

## 2.2.2 丝料

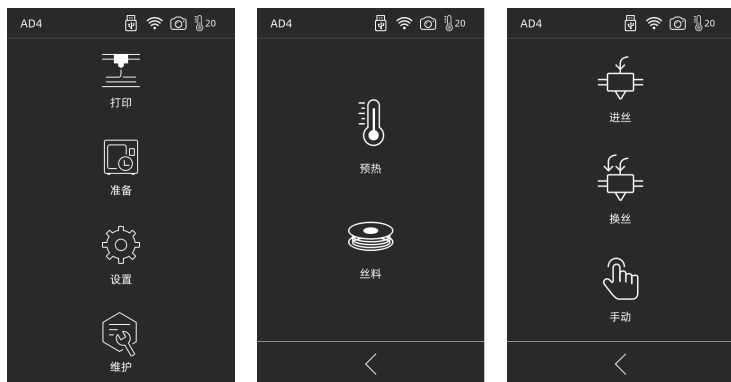

丝料包含进丝/换丝/手动

### 进丝

点击进丝后，喷头将加热到所设置的温度；根据界面提示来完成进丝操作。需注意自动模式时采取快速+慢速进丝模式，只需将丝料放置在送丝轮处。自动模式切勿将丝料推到导丝管内部。进丝太快容易引起异响。

### 换丝

点击换丝后，喷头将加热到所设置的温度；根据界面提示抽出丝料；将新丝料放入进丝口，感受到阻力即可；当喷头出丝时表明换丝完成。



### 手动

点击手动后，喷头将加热到所设置的温度；选择对应长度后，选择进/退丝。



#### 注意事项

若导丝管内有丝料，建议使用手动模式操作；一般建议使用自动模式。

## 2.3 设置



设置包含移动、网络、风扇、语言、状态、相机、亮度、灯、丝料检测、声音、命名设备、关于、恢复出厂。

- ✚ 移动：移动喷头左右移动、平台前后移动；注意喷头若移动超出到最左边运动量程会发出异响为正常现象；平台移动到最前面超出运动量程后，发出异响为正常现象。
- 📶 网络：可连接设备热点/无线网络/闪铸云/Polar云；
- 🌀 风扇：可控制腔体风扇开/关；
- Ⓐ 语言：根据地区选择合适的语言；
- 🌡️ 状态：显示设备温度，坐标等；



- 📷 相机：可进行远程查看；开启摄像头，开启延时视频时，在打印过程中将会录制延时视频，存储在内存中；可在图片中查询。点击拍照，将会拍摄当前画面以照片形式存储。
- ☀️ 亮度：调节屏幕亮度；
- 💡 灯：喷头灯开/关；
- 👁️ 丝料检测：开关丝料检测传感器；
- 🔔 声音：开关设备开机启动声音以及屏幕点击的声音；
- 📄 命名设备：用户可自定义命名设备；
- ℹ️ 关于：设备的信息；
- 🔄 恢复出厂：恢复原始出厂的信息。

## 2.4 维护



### 维护

-  在线升级
-  日志
-  喷头校准
-  喷头更换
-  日常维护

### 2.4.1 在线升级

当设备已连接网络时，新固件发布时将会提示可升级；

### 2.4.2 日志

设备遇到异常运动时可通过复制日志将问题反馈给闪铸官方售后团队。

### 2.4.3 喷头校准



设备第一次使用或更换喷嘴后需要进行喷嘴高度与平台之间的距离校准；

**专家模式：**适合经验较多的用户使用，直接判断喷嘴与平台的距离进行直接调整。

点击  喷头向上运动，点击  喷头向下运动。



**普通模式：**包含了喷头校准以及9点调平补偿功能

用户点击校准后，机器开始预校准，第一个点为校准喷头与平台间的初始距离，点击上下箭头可调节Z轴偏差值；在喷嘴与平台之间插入调平卡，来回抽动查看是否有略微的摩擦阻力，如有，即为合适距离。一般情况下可以不继续调整。当喷头校准后仍无法较好的打印大面积模型，或者打印模型由于平台不平而导致失败时，请做完整的9点调平操作，校准全部的9个点，校准完成后，软件将会自动计算一个补偿均值进行补偿；校准每个点时，用户也可自己通过点击上下箭头来调节Z轴偏差值；补偿完成后，数值被计算应用。

#### 2.4.4 喷头更换

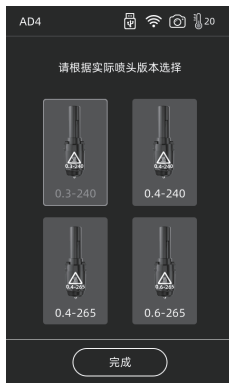

安装新喷嘴后，请根据所换喷嘴的温度值做补偿值设置；喷头实际偏差范围：-10~30。点击下一步进入选择喷头界面。选择所安装的新喷嘴，预热中会根据选择的喷嘴类型而设定最高温度。请确保安装的喷嘴与选择的喷嘴类型一致，点击完成回到维护界面。

**⚠ 注意事项** 更换不同的喷嘴，预热的默认最高温度会变为所更换的喷嘴温度。

## 2.4.5 维护建议



遇到异常或操作不明确时先查看维护建议。根据维护指导操做。

# 第三章 软件安装

方法一：在U盘中找到FlashPrint软件安装包，选择对应的系统版本进行安装。

方法二：从官方网站 [www.sz3dp.com](http://www.sz3dp.com) 下载最新的切片软件。

# 第四章 设备预准备



设备出厂经过调平校准，但由于运输等情况，喷嘴与平台间距可能发生变化，建议在开箱后进行一次【喷头校准】。

此步骤非完全必要操作。具体操作见界面功能介绍。

# 第五章 首次打印

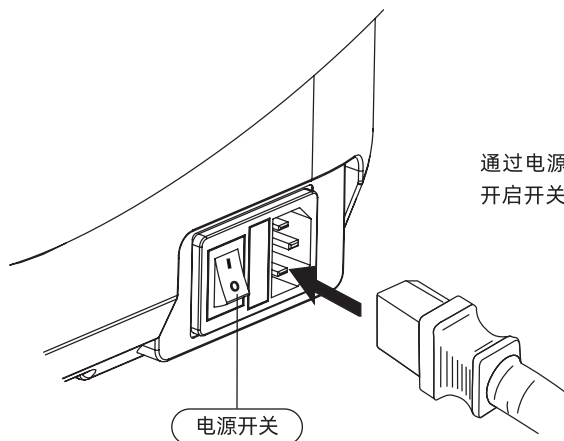

通过电源线连接电源与打印机；  
开启开关，屏幕点亮。

1. 连接电源。

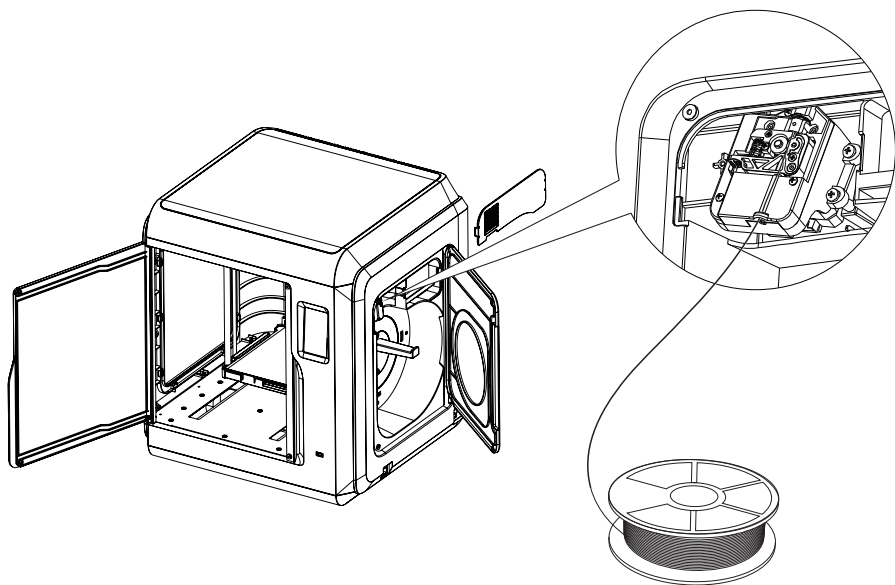

2. 安装丝料：打开右侧耗材门，将丝料插入进丝口，推入送丝轮内，感受到一定阻力即可。请务必确认丝料已经推入送丝轮。点击屏幕准备-丝料-进丝。按屏幕指示操作，待喷嘴吐出丝料说明进丝完成。





### ⚠ 注意事项

打印机连接的网络和电脑连接的网络必须在同一网段中，否则无法连接成功。

## 3. 传输文件

### 方式一：传输WiFi

点击设备的设置-网络-WiFi，按屏幕提示连接即可；打开FlashPrint，点击菜单中的打印按钮，选择冒险家4连接机器；可通过输入IP地址或自动扫描的方式，IP地址可在设备设置-关于中查看。

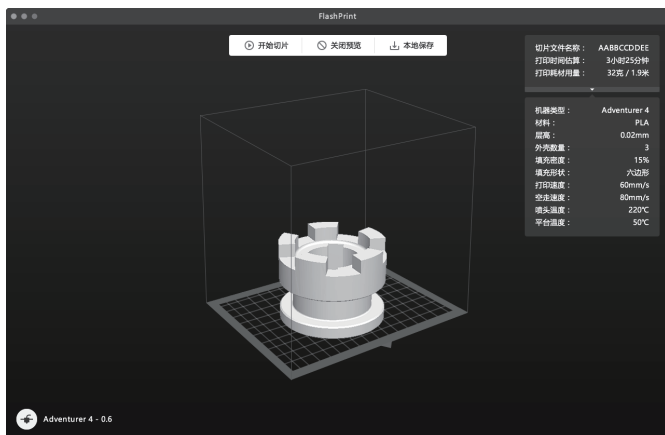

将stl或obj文件导入到切片软件中；进行切片，软件切片完成后，打印机进行加温等工作，准备完成后自动开始打印。

### 方式二：U盘打印

设备也可通过U盘打印，将切片好的文件保存至U盘，将U盘插入到设备，选择对应文件点击打印。

## 方式三：云打印

### 闪铸云打印

(1) 打开闪铸云网站，注册账号，经过邮箱激活后，即可登录使用。

闪铸云：<https://cloud.sz3dp.com>



(2) 点击【我的打印机】-【添加打印机】。

在添加打印机页面填写注册号（云注册码），为打印机起个名字，点击确定后，这些信息会出现在打印机的闪铸云界面。

### Polar 云打印

打开Polar云网站，注册账号。

Polar云：<https://Polar3d.com>

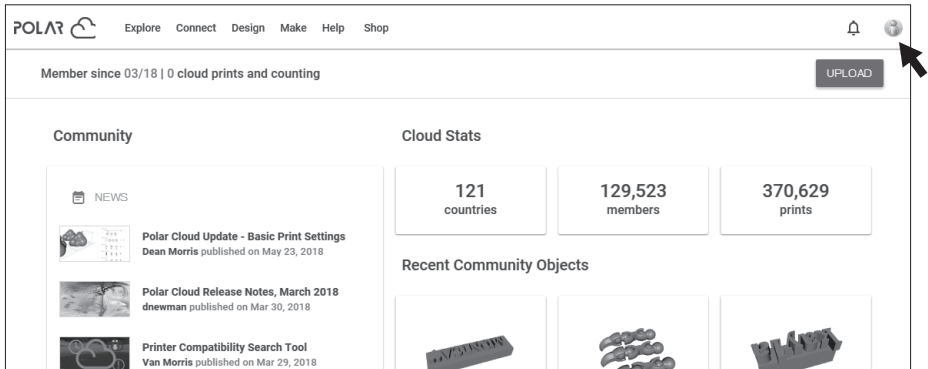

登录后，点击右上角头像图标，点击【Settings】，点击菜单中的PIN Code 查询PIN码。冒险家4 连接网络后打开Polar 云开关，输入账号与PIN码即可。

#### 4. 打印后模型移除

直接取出平台柔性钢板，折弯平台即可取下模型。

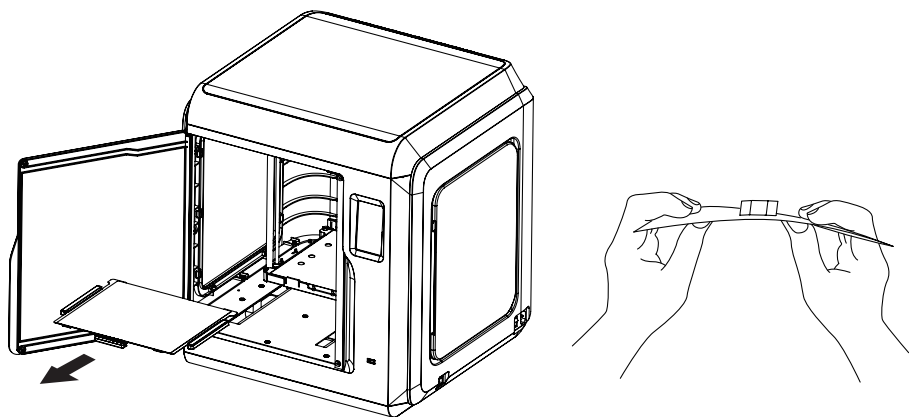

#### ⚠ 注意事项

打印完成时，喷嘴和打印平台仍处于高温状态，建议冷却后操作。

模型移除建议将平台板拿到设备外部再进行移除，否则模型碎屑容易留在设备腔体内，建议保持腔体清洁。

# 第六章 Q&A

## Q1. 喷嘴堵头怎么办？

方案1：点击预热按钮，将喷嘴温度加热至所用耗材的打印温度，待加温完成，按压气管接口，拔出导丝管，查看丝料是否弯折，丝料头部是否平整。若不是，剪平整后，将导丝管与丝料装入喷头，再点击进丝查看。

方案2：方案1无改善，则使用通针通丝。

方案3：若使用通针通丝仍无法解决堵头问题，请更换喷嘴。

## Q2. 如何更换喷嘴？

**⚠ 注意事项** 更换喷嘴请先关机断电，请勿带电操作。

1. 按压住左右扣，同时拔出喷嘴；
2. 在进丝口手动推丝，使其伸出足够长度方便剪断丝料；
3. 手动逆时针转动料盘，使丝料后退一些；
4. 按住左右扣，将新喷嘴插入喷头中，确保喷嘴卡槽位与喷头下部齐平；
5. 点击屏幕中的准备--进丝，直到丝料吐出，喷嘴更换完成。

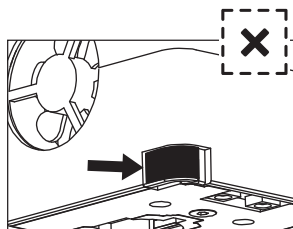
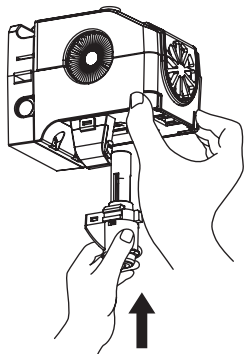
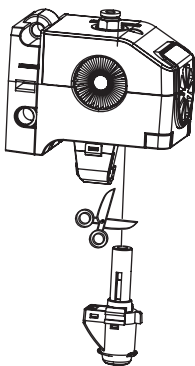
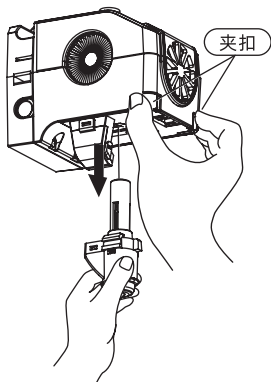

有缝隙，未安装到位

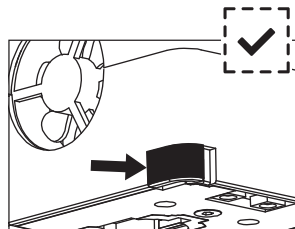

无缝隙，安装到位

喷头装配是否到位的判断如下：

1. 安装必须用力将喷头按压到底；

2. 检查是否安装到位：

① 用手触摸黑色卡扣与白色喷头下壳无凹陷；

② 肉眼观察黑色卡扣与白色喷头下壳接触处无较大间隙。

### Q3. 更换喷嘴后需要喷头校准吗？

需要校准，喷头安装可能会产生微小误差，为保证打印质量，建议请进行喷头校准。

### Q4. 点击打印模型，喷头运动，但打印一开始就没有出丝怎么办？

1. 观察导丝管，确认丝料是否已进入喷头，若无，请再点击进丝按钮，直至丝料从喷头中吐出；
2. 查看喷头是否堵头，若是，解决方案请查看Q1。

### Q5. 打印时发现喷嘴与平台相对位置过高（远离平台）或过低（顶到平台）怎么办？如何调平？

1. 点击维护--进行喷头校准；
2. 机器开始预校准，第一个点为校准喷头与平台间的初始距离（见Z轴偏差值），点击上下箭头可调节Z轴偏差值；借助调平卡来回抽动感是否有略微的阻力，如有，即为合适距离。
3. 当喷头校准后仍无法较好的打印大面积模型，或者打印模型由于平台不平而导致失败时，请继续使用该功能，机器会校准其余8点，校准完成后，软件将会自动计算一个补偿均值进行补偿；校准每个点时，用户也可自己通过点击上下箭头来调节Z轴偏差值；补偿完成后，记忆数值，喷头回零。

### Q6. 可以使用其他品牌的丝料吗？

冒险家4支持ABS、PLA、PC、PETG、PLA-CF、PETG-CF等材料，各品牌材料配方略有不同，冒险家4根据闪铸科技ABS、PLA、PC、PETG、PLA-CF、PETG-CF等材料特性，调试确定最佳温度、出丝量等默认参数值，确保模型打印质量。其他品牌丝料可以使用但需要经过参数调整，由于不同材料温度差异略有区别，更换耗材时建议将前一次耗材清理完再使用新耗材，否则容易引起喷头堵塞。

### Q7. 冒险家4兼容所有AC输入吗？

冒险家4包含了一个24V/13.3A的内置电源，适配于100V-240V的输入电压。

### Q8. 冒险家4能打印完成自动关机吗？

不能。

### Q9. 冒险家4支持什么样的文件格式？

输入：3MF/STL/OBJ/FPP/BMP/PNG/JPG/JPEG 文件  
输出：GX/G文件

### Q10. 冒险家4除支持3D Cloud 云之外，支持其他云平台吗？

支持，冒险家4的开放性接口支持其他云平台。

### Q11. 打印ABS 材料安全吗？

ABS在加热过程中会释放有毒气体，打印时或者打印后可开启HEPA的空气过滤器，但还是建议置于开阔空气流通的环境下打印。儿童活动场所建议打印PLA无毒材料。

### Q12. 打印模型发生翘边或粘不牢现象怎么办？

方案1：增加平台温度可有效缓解此问题，增加平台与模型的粘附力。

方案2：模型切片时选择底板，可有效缓解此问题。

方案3：涂抹胶水。

方案4：喷嘴与平台的间隙过大，可相应减小间隙，使用喷头校准专家模式或调平校准功能进行调整。

方案5：确认平台是否放平。可使用调平校准功能，建议执行完全流程的9点调平。

方案6：使用喷头校准功能减小间隙。

### Q13. 打印模型是必须要增加底板吗？

不一定，打印底板时出丝量较多，打印成功率较高，在底板加热的条件下，模型与平台板的粘附性增加，使得模型打印时能很好的粘附在平台上，同样也能增加打印成功率。

### Q14. 更换完喷嘴后的注意事项及更换后状态显示喷头温度300°C，并且喷头上的风扇转是怎么回事？

**注意事项：**

注意切片文件中的温度设置，可能会和切换后的喷嘴最高温度不匹配。

**异常情况：**

温度显示异常说明喷头传感器没有被读取到，说明喷嘴安装不到位，请重新插拔安装喷头，并将喷头推到底，确保卡扣处与喷头下方齐平。具体可查看Q2。

**⚠ 注意事项** 更换喷嘴时请关闭电源。

### Q15. 进丝机构发出突突的响声，并且喷头一直不出丝怎么办？

进丝机构发出突突的响声，说明丝料无法进入到喷头中，极大可能喷头堵头或导丝管位置安装不到位。请首先按下导丝管接头检查导丝管连接是否正常。若正常请再参照问题Q1。

### Q16. 进丝、换丝和手动有什么区别？

进丝功能：只包含将丝料送入喷头；

换丝功能：包含进丝与退丝两个功能，先退丝后进丝。先快速送丝，后慢速送丝；

手动功能：采用慢速进丝。

**⚠ 注意事项** 手动功能建议在测试喷嘴是否能出丝时使用，不建议当进丝功能使用。如果当进丝功能使用，请选择最高长度。

### Q17. 选择文件开始打印时，喷头下降到仍与平台有一定悬空距离处就开始打印，导致丝料无法黏在底板上怎么办？

请重新校准或者重新回零再打印。

### Q18. 插入U盘，找不到打印文件，并且全为文件夹怎么办？

U盘格式不正确，冒险家4只支持FAT32格式的文件系统，请将U盘格式化成FAT32格式。

### Q19. 如何连接Polar云?

1. 打开Polar云网址，登陆账号密码。<https://polar3d.com>;
2. 打开右上角云账户个人信息，往下翻到底查看PIN码;
3. 打开打印机Polar云界面，输入账号和PIN码;
4. 打开Polar云开关，连接Polar云。

### Q20. 如何连接Flash云?

1. 打开闪铸云网址：<https://cloud.sz3dp.com/login.html>;
2. 打开打印机闪铸云界面或者关于界面;
3. 在闪铸云网址上添加打印机，输入名称和打印机的注册码;
4. 打开打印机的闪铸云开关按钮连接闪铸云。

### Q21. 如何使用相机功能?

1. 启用摄像功能，可在云上看到视频;
2. 启用视频延时功能会在打印中截取100张图片保存下来，打印完成后压缩成视频。

**⚠ 注意事项** 图片能保持10个模型，视频能保存20个。

### Q22. 移动中的隐藏小知识

1. 没有选中长度时按下按钮开始运动，松开按钮停止运动;
2. 选中长度时按下开始运动，松开不会停止，一直走到对应长度才会停止。

**⚠ 注意事项** 靠边运动时注意距离，防止撞击边框。

### Q23. 进丝时齿轮异响?

机器采用快慢进丝，所以请确保进丝时导丝管中没有剩余丝料。

### Q24. 校准时何为专家模式?

专家模式直接调整间隙数值，适合有经验的用户操作，详情可查看校准说明中的专家模式讲解。

### Q25. 打印过程中如何调整打印参数?

进入打印详情界面调整参数，注意调整后可能会延时生效或者调整不合理会影响打印质量，请慎重设置。

### Q26. WiFi连接不上怎么办?

1. 请检查WiFi热点名称是否有特殊字符，如果有请修改之后再次尝试;
2. 请检查密码是否有特殊字符，如果有请修改之后再次尝试。

**⚠ 注意事项** 一定要确定密码输入正确。

## Q27. 更新固件注意事项

请不要在下载或更新的过程中断电断网，防止更新失败。

## Q28. 为什么开机屏幕白屏，不显示固件？

1. 如果听得到开机声音，请更换屏幕或者排线；
2. 如果听不到开机声音，请联系供应商。

### 日常维护说明

当打印机处于长期闲置状态时，请在导轨上涂抹润滑油，或每隔一个月定期涂抹；请将耗材放在干燥盒中，以免受潮。

若时常打印，建议2周更换一次HEPA 过滤棉；  
更换方式：

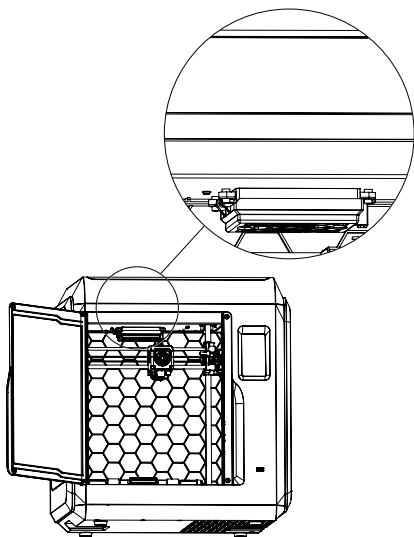

1. 打开打印机前门，找到空气过滤装置。  
如图所示位置。

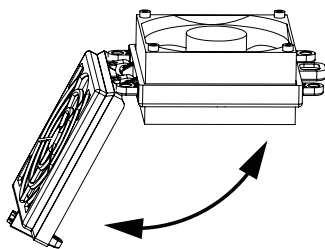

2. 打开空气过滤盖，将新的滤棉放入，盖上过滤盖。



# 第七章 帮助与支持

---

闪铸专业的售后服务人员及业务员随时为您待命，非常乐意为您解决在你使用过程中遇到的任何问题。如果你的问题从用户手册中找不到答案，你可以进入我们的官方网站来搜索问题的解决方案，当然您也可以通过电话或QQ联系我们。

在我们的官网中可以找到一些常见问题的说明和解决方法。您的许多问题都可以在闪铸科技官方网站 [www.sz3dp.com](http://www.sz3dp.com) 得到解决。

您可以在周一到周六的上午8:00到下午5:00的时间段通过电话和QQ来联系闪铸的售后团队，为您解决问题。如果您刚好在下班时间联系我们，我们将在下一个工作日的第一时间给您反馈，为您解决问题，若造成不便，我们万分抱歉。

**提示：**由于更换不同的丝料，会有少量杂质残留在喷头中造成喷头堵塞，疏通后即可，不属于质量问题，不在400小时寿命范围内，若用户使用时存在该问题，请联系售后，并在售后的指导下完成疏通工作。

售后服务热线：400-8866023

售后客服QQ：2850862986 / 2850863000 / 2853382161

3D爱好者QQ群：206773820

公司地址：浙江省金华市婺城区仙源路518号

**提示：**联系售后时，需提供产品序列号，也就是打印机背部的条形码。









Follow us

**Zhejiang Flashforge 3D Technology Co., Ltd.**

Address: No.518 XianYuan Road, Jinhua City,Zhejiang Province, China

Service Hotline: +86 579 82273989

[support@flashforge.com](mailto:support@flashforge.com)