



 **User Manual**

# PHOTON MONO 4K

Dear customer,

Thank you for choosing **ANYCUBIC** products.

Maybe you are familiar with 3D printing technology or have purchased **ANYCUBIC** printers before, we still highly recommend that you read this manual carefully. The installation techniques and precautions in this manual can help you avoid any unnecessary damage or frustration.

Please visit <https://www.anycubic.com/pages/contact-us> to contact us if you have any question. You can also gain more information such as software, videos, models from the website.



**ANYCUBIC** support center

Team **ANYCUBIC**

Copyrighted by "Shenzhen Anycubic Technology Co., Ltd ", all rights reserved.

# Safety Instructions

*Always follow the safety instructions during assembly and usage, to avoid unnecessary damage to the 3D printer or individual injury*



Please contact our customer service first if you have any issue after receiving the products.



Be cautious when using the scraper. Never direct the scraper towards your hands.



In case of emergency, please immediately cut off the power of **ANYCUBIC** 3D printer and contact the technical support.



**ANYCUBIC** 3Dprinter includes moving parts that can cause injury.



It is recommended to use protection glasses when sanding the printed models to avoid eye contact with small particles.



Keep the **ANYCUBIC** 3D printer and its accessories out of the reach of children.



Vapors or fumes may be irritating at operating temperature. Always use the **ANYCUBIC** 3D printer in an open and well ventilated area.



**ANYCUBIC** 3D printer must not be exposed to water or rain.



Operate **ANYCUBIC** 3D printer with a temperature of 8°C-35°C and a humidity of 20%-50%. For optimal performance, do not exceed this range. Also, avoid direct sunlight exposure.



Do not disassemble **ANYCUBIC** 3D printer, please contact technical support if you have any question.

# Contents

1. Technical Specification	5
2. Packing List	7
3. Product Overview	8
4. Menu Directory	9
5. Assembly and Leveling Instructions	12
6. First Print Instructions	16
7. Slicing Software Overview	19
8. FAQ and Machine Maintenance	20

# Technical Specification

---

## Printing

System	ANYCUBIC Photon Mono 4K
Operation	2.8-inch Color TFT Screen
Software	ANYCUBIC Photon Workshop
Connectivity	USB memory stick

## Specifications

Technique	LCD Shadow Masking
Light source	UV-LED (wavelength 405nm)
XY Resolution	3840*2400 (4K)
Z axis Accuracy	0.01 mm
Suggested Layer Thickness	0.01-0.15 mm
Print Speed	Max 50 mm/h
Rated power	45 W

## Physical Dimensions

Dimension	222 mm (L) *227 mm (W) *383 mm (H)
Build volume	132 mm(L)*80mm(W) *165 mm (H)
Materials	405nm UV-resin
Net weight	~4.25 kg

# Technical Specification

## Recommended Printing Parameters







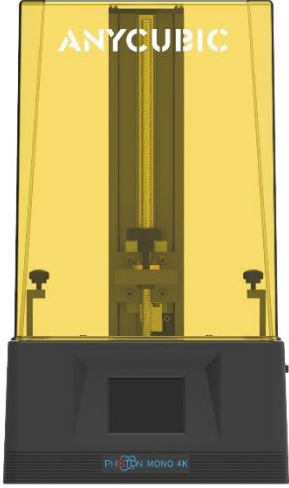
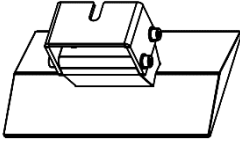
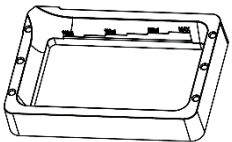

Layer Thickness	0.05 mm
UV power	100%
Normal Exposure Time	2 s
Off Time	0.5 s
Bottom Exposure Time	40 s
Bottom Layers	6
Z Lift Distance	6 mm
Z Lift Speed	4 mm/s
Z Retract Speed	6 mm/s
Anti-alias	1

### Note:

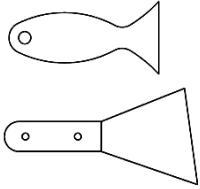
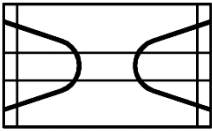
- 1.The recommended printing parameters above is for reference only, which is more suitable for Anycubic resin.
2. The UV power of the machine is high. If there are solid residue in the resin vat or on the printing platform frequently, please decrease the UV power and increase the normal exposure time.

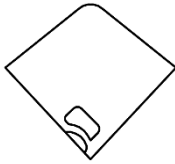

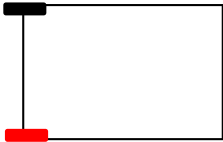
# Packing List

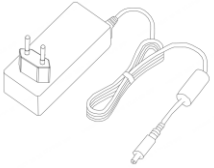
			
	<p>Print platform 1PC</p>	<p>Resin vat 1PC</p>	
			
<p>Photon Mono 4K</p>	<p>USB memory 1PC</p>	<p>Scrapers 2PCS</p>	
			
<p>Mask 1PC</p>	<p>Gloves 3Pairs</p>	<p>Funnel 5PCS</p>	<p>Assembly Instruction 1PC</p>
			
<p>Leveling paper 1PC</p>	<p>Screen protector kit</p>	<p>Tool kit</p>	<p>Power adaptor 1PC</p>

# Product Overview

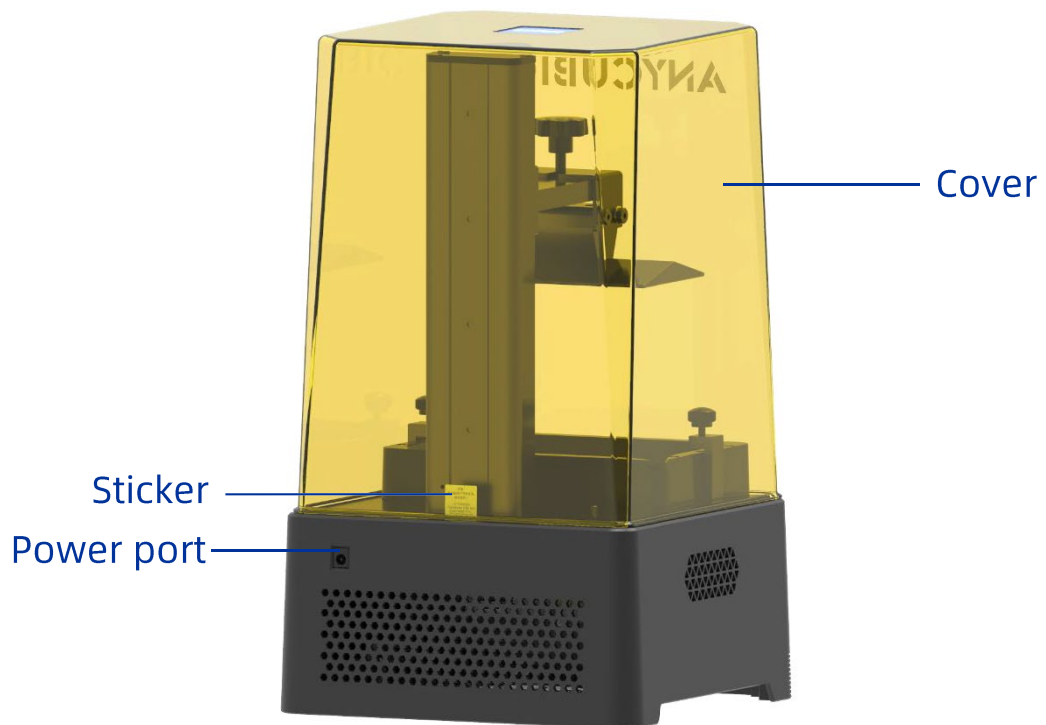
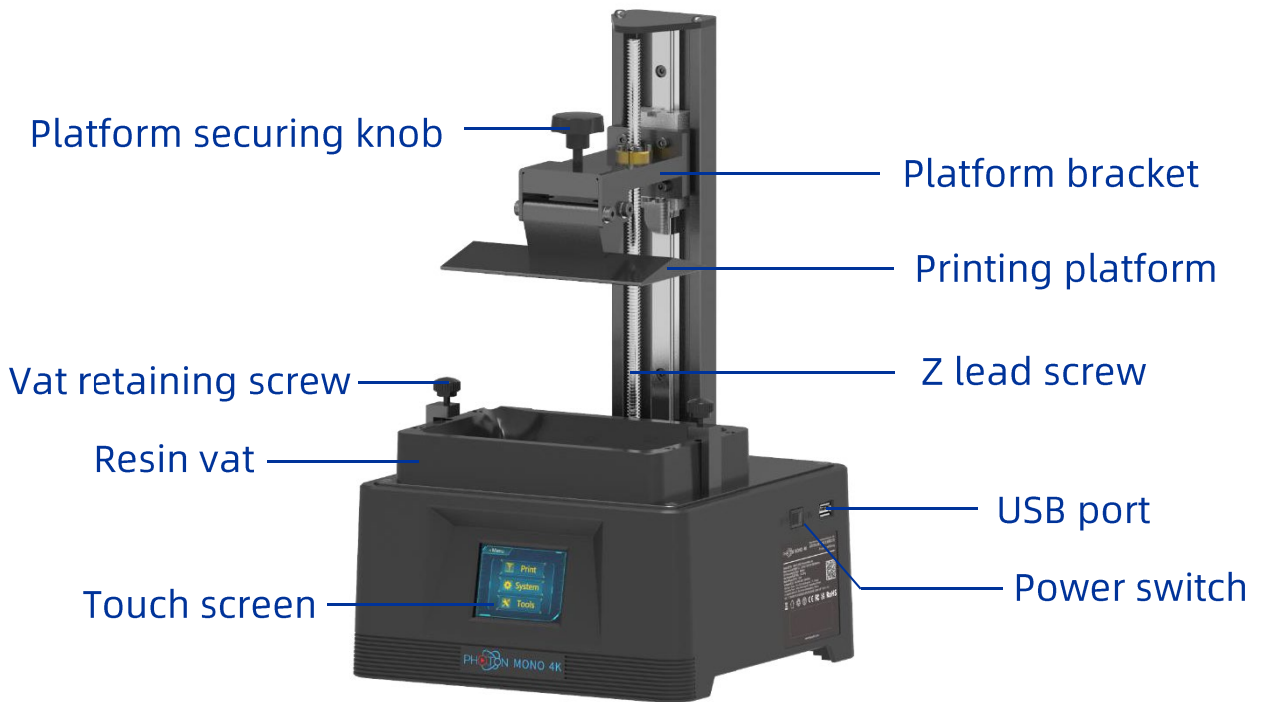



# Menu Directory

Home menu



Print

System

Tools

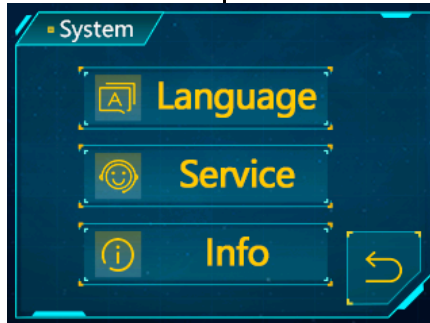
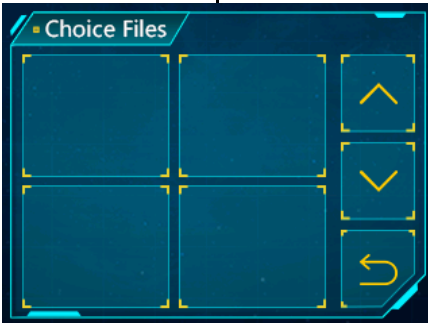

## Home menu

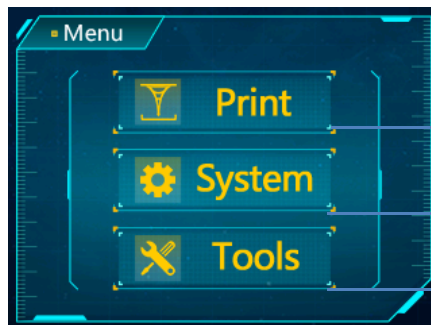

Enter Print Menu

Enter System Menu

Enter Tools Menu

# Menu Directory

## Print

### File List:

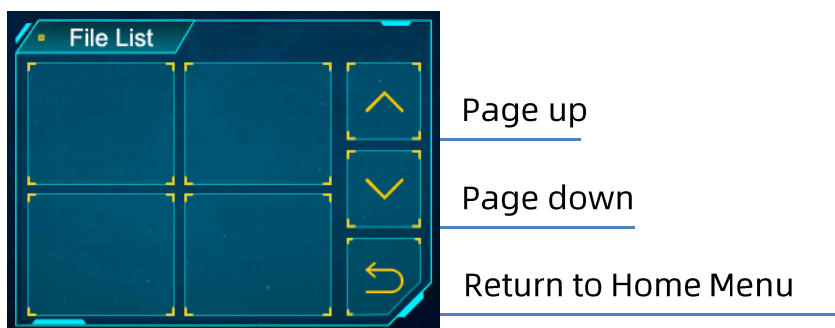

### Click Files

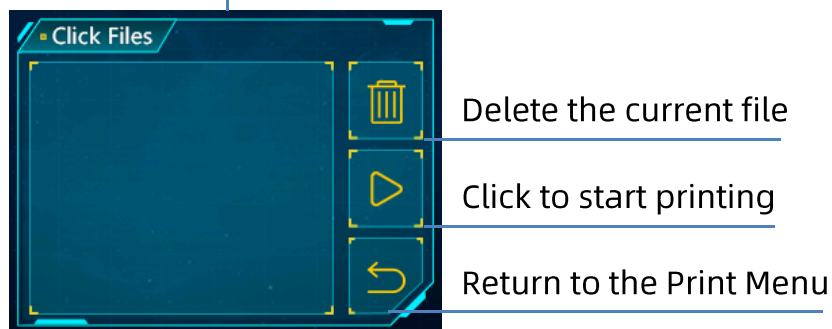

## System

**Language:** Change language(English/Chinese)

### Service:

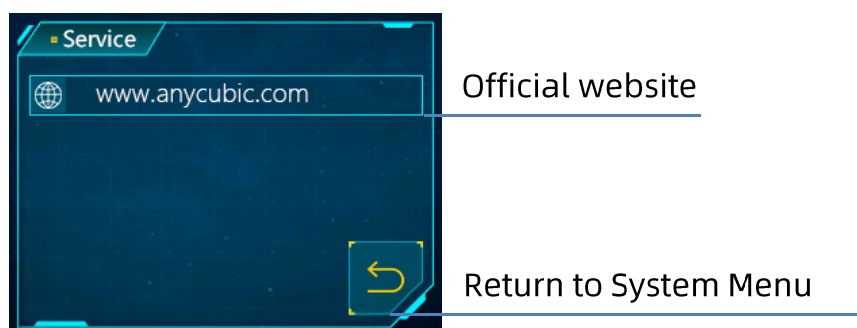

### Information:

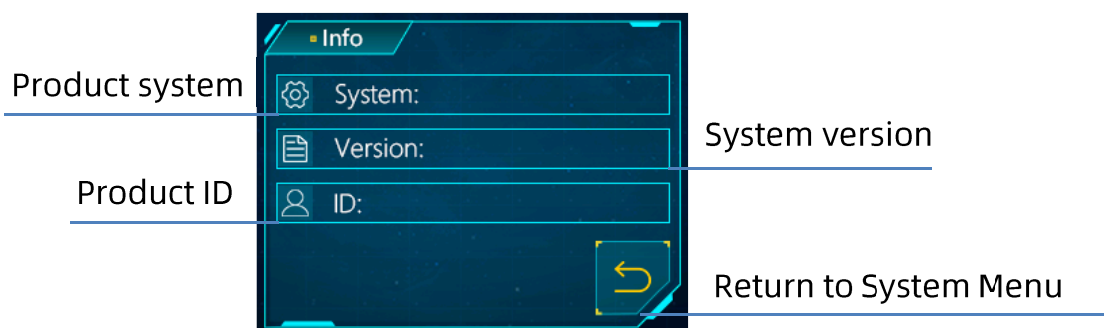

# Menu Directory

## Tools

### Move Z:



The 'Move Z' menu features a title bar with a yellow arrow and the text 'Move Z'. Below the title bar are three buttons labeled '0.1mm', '1mm', and '10mm'. The main area contains a 2x3 grid of icons: an upward-pointing chevron, a downward-pointing chevron, a house icon, a circle with a diagonal slash, and a curved arrow pointing left. A 'Return to Tools Menu' button is located at the bottom right.

Move Z by 0.1mm/1mm/10mm

Move the Z axis upwards

Return to Zero

Stop moving the Z axis

Return to Tools Menu

Move the Z axis downwards

### Detection:



The 'Detection' menu features a title bar with a yellow arrow and the text 'Detection'. Below the title bar are three buttons showing different image shapes: a rectangle, a square, and a horizontal bar. The main area contains a 2x3 grid of icons: a button with the letter 'S', an upward-pointing chevron, a downward-pointing chevron, a 'Next' button, and a curved arrow pointing left. A 'Return to Tools Menu' button is located at the bottom right.

Select one of the images to detect

Click to set the test time

Reduce the test time

Test LED and DMD for the preset time

Return to Tools Menu

Increase the test time

### More:



The 'Tools' menu features a title bar with a yellow arrow and the text 'Tools'. Below the title bar are two buttons labeled 'UV Power' and 'Door Sensor'. A 'Return to Tools Menu' button is located at the bottom right.

Click to set UV power

Click to enable/disable Door detection

Return to Tools Menu

**Z=0:** Reset the zero point

**Horn icon:** Turn on/off the screen sound

# Assembly and Leveling Instructions

1. Unpack the machine and take out the accessories. Then plug in the power cord and turn on the printer.



2. Rise the Z axis to a certain height to ensure that the curing screen will not be scratched when printing platform is installed.

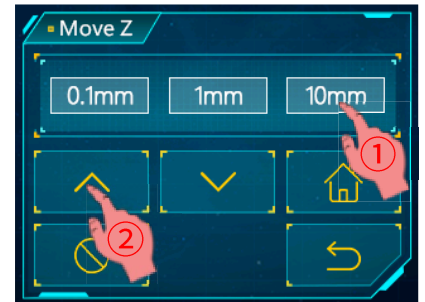
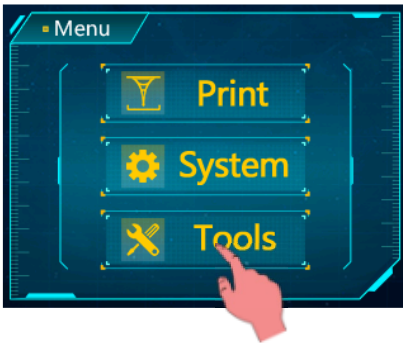

3. Tear off the protective film before leveling and printing.

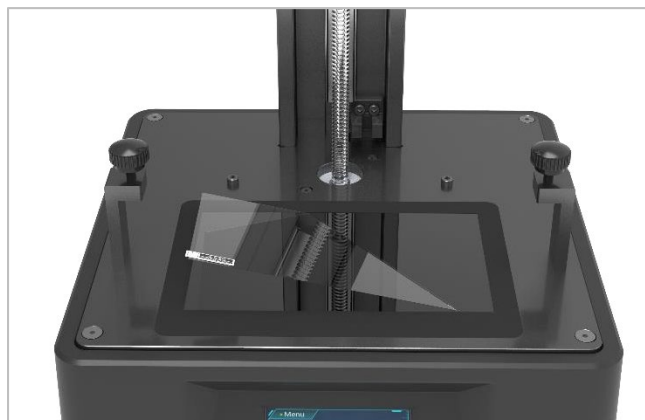

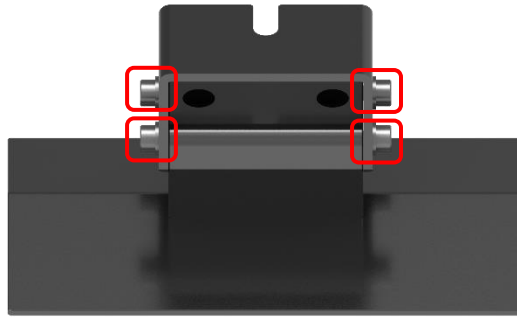

# Assembly and Leveling Instructions

4. Peel off the packing film on the printing platform, then loosen the four screws.

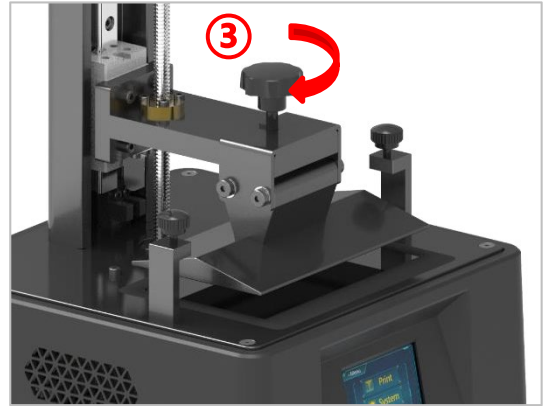
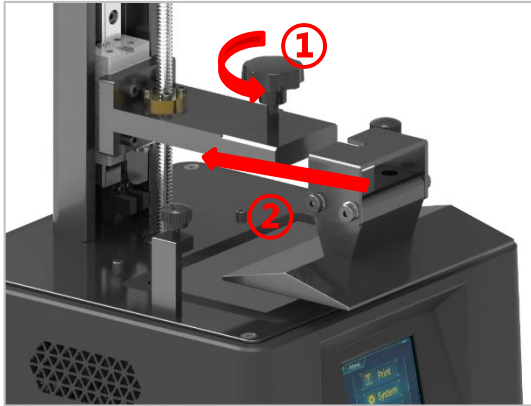

5. Install the printing platform.



6. Place a leveling paper on the curing screen. Then click “  ” on the touch screen. Wait for the Z axis to descend and stop automatically.

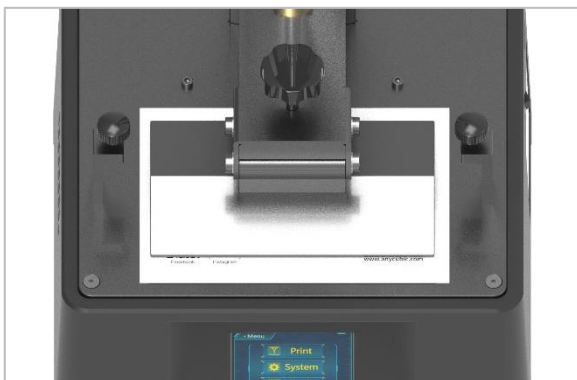

# Assembly and Leveling Instructions

7. Use your fingers to press the platform gently, to let it fit evenly on the curing screen. Then tighten the four screws on the platform.



8. Click “Tools” → “Z=0” on the touch screen, and then click “Enter” on the pop-up window. Till now, the leveling process is finished. Click “Enter” again on the pop-up window and pull out the paper.

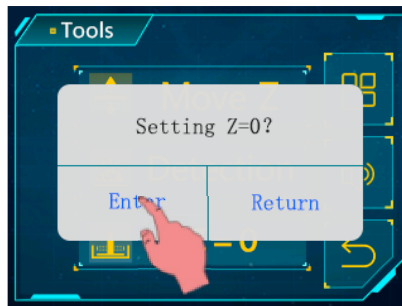

9. Testing UV light: Click “Tools” → “Detection”, select a image and the test time, and then click “Next” on the screen as shown below. It should display a complete image as what you select. Otherwise, the UV light may have sort of malfunction, please contact tech support.

# Assembly and Leveling Instructions

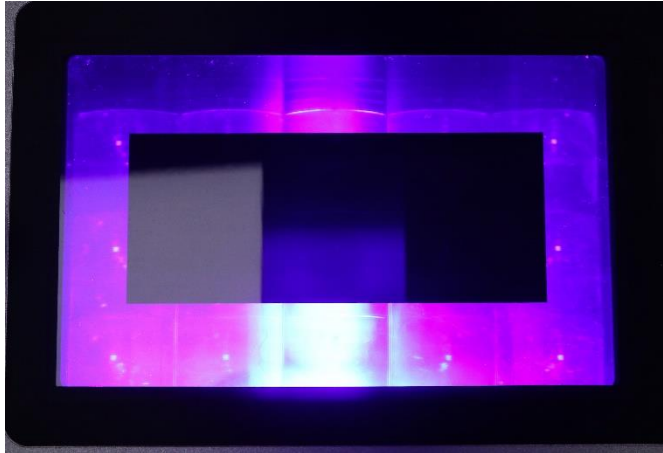
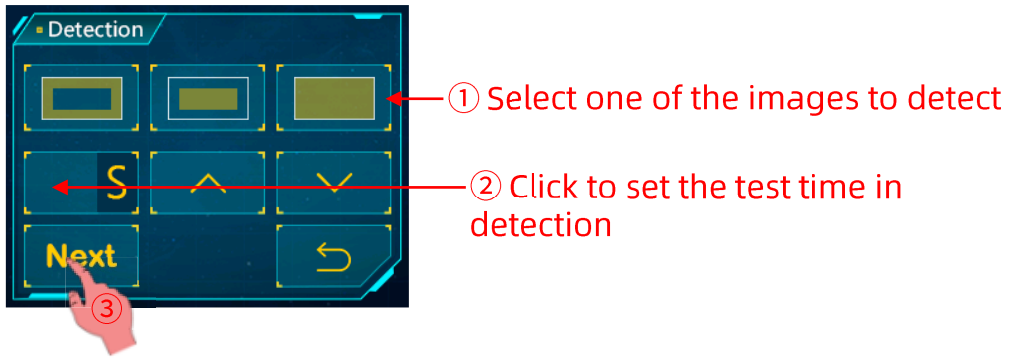

the result of first image

10. Install the resin vat. **Please use the plastic resin vat provided with the machine or Anycubic Photon Mono black resin vat. Do not use metal vat, which may cause print failure.**



# First Print Instructions

## 1. Print

Insert the USB memory (the test file "TEST.pwma" has been saved in it) into the USB port. **Then wear masks and gloves (to avoid direct skin contact with resin)**, slowly pour the resin into the vat and the resin cannot exceed the vat's maximum scale.

After that, put on the cover. Take off the gloves, select the "TEST.pwma" test file and start printing. (The printing time on the screen is for reference only, we make no guarantee that it is the actual printing time.)

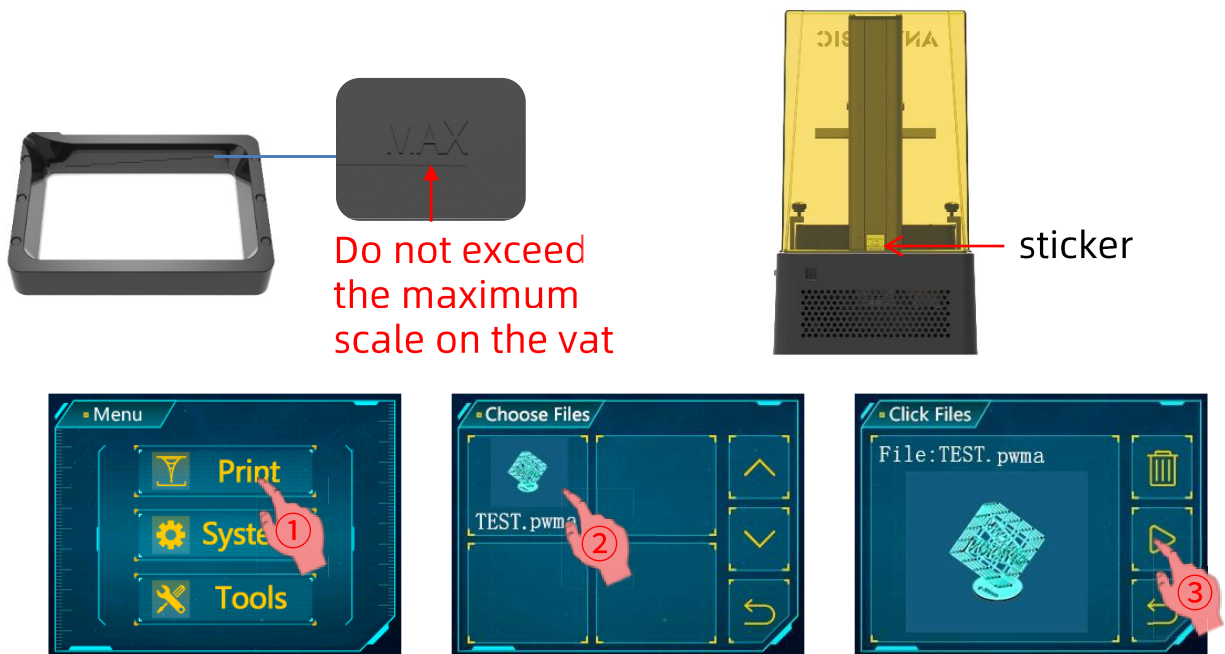

If you think the resin is insufficient to finish an ongoing print (or you want to change the resin), you can click "Pause", the platform will rise, and you can slowly add (or change) the resin. After that, click "Start" to resume.

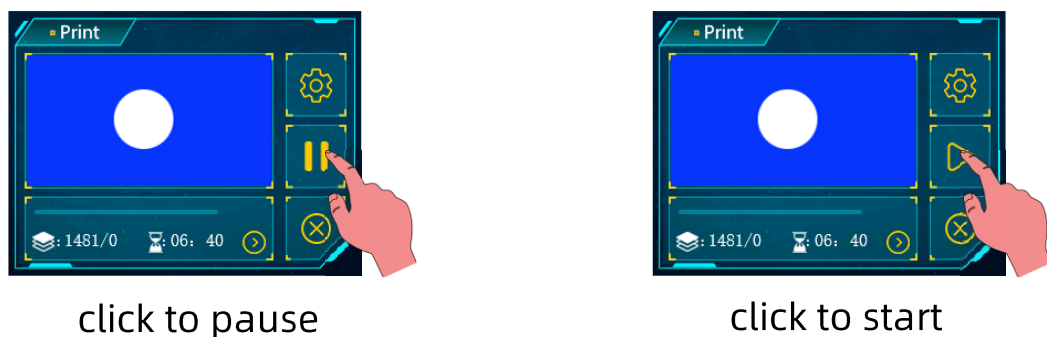



# First Print Instructions

## 2. Door detection function

Door detection function is disabled by default. If this function is enabled, the printer can detect whether the cover is on or not. Printing will pause when the cover is removed, and will continue when the cover is put back.

Click "  " on the "Tools" interface, then click ON/OFF to enable/disable this function.

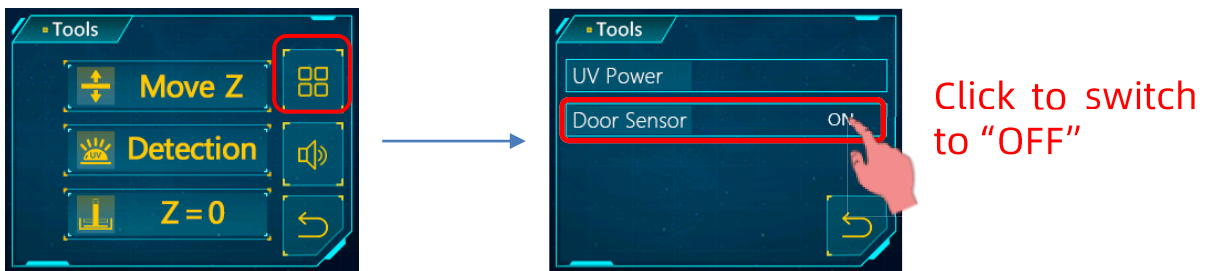

## 3. Set UV power

There are two ways to set UV power.

Before printing, click "Tools" → "  ". Then click "UV power" in the setup interface to set UV power.

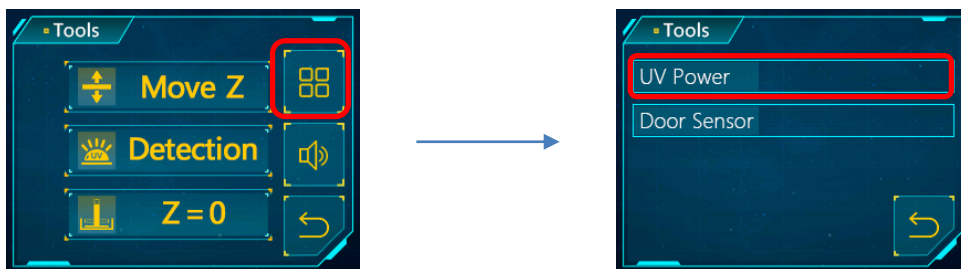

Besides, in the process of printing, click "  " in Print interface, page down to find "UV power". Then click it to set UV power.

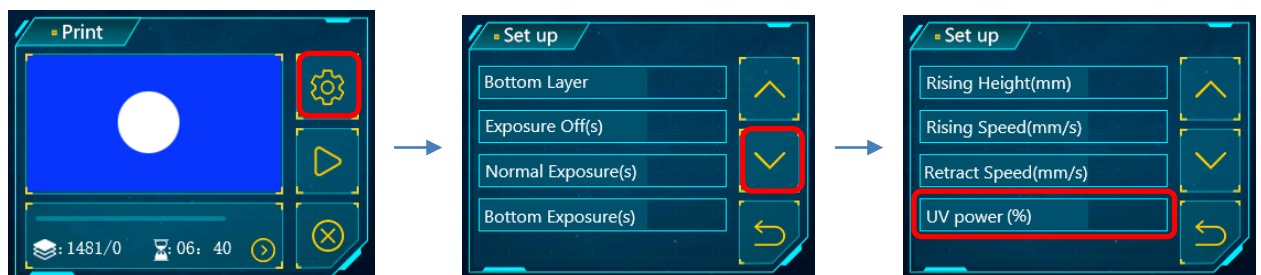

# First Print Instructions

## 4. Handling models and residues

After printing, unscrew and remove the platform when resin stop dropping from the platform. The model can be removed by scrapper carefully. The removed model should be washed with ethanol 95vol% concentration. The printed object may need post curing to achieve better hardness by direct **sunlight** or UV-curing box.



**【IMPORTANT】** Inevitably, in case of incomplete curing or failed prints, there might be some cured resin left in the vat. It is suggested to filter the resin by a funnel and then store the liquid in a sealed container. The residues left on the platform or in the vat can be wiped off with paper towel.

Before each prints, please ensure there is no solid residues in the vat or on the platform, otherwise the FEP film may be crushed and broken during printing.

# Slicing Software Overview

---

3D printer reads sliced file and prints models. It is necessary to convert 3D files (stl./obj.) into sliced files for machine to recognize. Software that realize the process is called slicing software, for example, Photon Workshop.

Photon Workshop can be used to export sliced file. You should select **Photon Mono 4K** as machine type first, then manipulate the model and set the parameters. Lastly, export the sliced file (**.pwma**).

The instruction of Photon Workshop has been saved in the USB memory, it is recommended that read it carefully if it is the first time for you to use Photon Workshop.

# FAQ and Machine Maintenance

## 1. FAQ

### (1) Model do not stick to platform

- Bottom exposure time is insufficient, increase the exposure time.
- Contact area between the model and platform is small, please add raft.
- Bad leveling.

### (2) Layer separation or splitting

- The machine is not stable during printing.
- FEP film in the vat is not tight enough or it need a change for new one.
- The printing platform or resin vat is not tightened.
- Add normal exposure time appropriately.
- The lift speed is too fast.
- The printing object is hollowed without punching.

### (3) Layer shift

- Add supports.
- Reduce the lift speed.

### (4) Floccules left in resin vat

- The exposure time is too long. Reduce the normal exposure time and bottom exposure time.

## 2. Machine maintenance



- (1) If Z axis make noisy sound, please apply lubricant to Z lead screw.

# FAQ and Machine Maintenance



(2) Clean off the residues cured on FEP film when the printing fail: Set full-screen exposure for 20s and then remove the cured resin sheet to protect the film. **Do not use sharp objects to scrape off the residues on FEP film.**

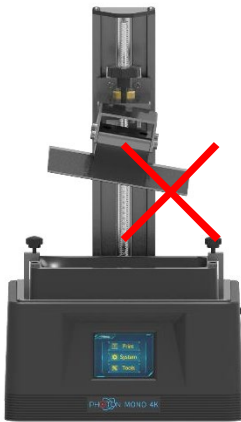

(3) Be careful when remove the platform, do not let it fall to damage the machine.

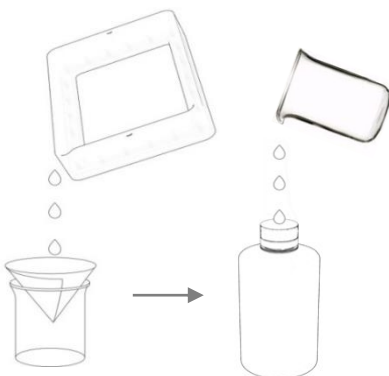

(4) Do not left resin in resin vat for over two days when it is unused. Please filter and store the resin properly.

# FAQ and Machine Maintenance

---

(5) After printing, please clean up the platform (**wipe with paper towels or wash with alcohol**), and ensure no residue left (**filter the residue with funnel**).

(6) If the body of printer is stained with resin, use alcohol to clean.

(7) Please clean the resin vat first before you change resin.

Thank you for purchasing **ANYCUBIC** products! Under normal usage and service, the products have a warranty period up to one year. Please visit **ANYCUBIC** support center([support.anycubic.com/en](https://support.anycubic.com/en)) to report any issue with **ANYCUBIC** products. Our professional after-sale service team would respond within 24 hours and solve the issues.